

# QuickScan™ L

## QD 2300 Bar Code Scanner



**Product Reference Guide**

**Datalogic ADC, Inc.**

959 Terry Street  
Eugene, OR 97402  
USA  
Telephone: (541) 683-5700  
Fax: (541) 345-7140

© 2007-2014 Datalogic ADC, Inc.

An Unpublished Work - All rights reserved. No part of the contents of this documentation or the procedures described therein may be reproduced or transmitted in any form or by any means without prior written permission of Datalogic ADC, Inc. or its subsidiaries or affiliates ("Datalogic" or "Datalogic ADC"). Owners of Datalogic products are hereby granted a non-exclusive, revocable license to reproduce and transmit this documentation for the purchaser's own internal business purposes. Purchaser shall not remove or alter any proprietary notices, including copyright notices, contained in this documentation and shall ensure that all notices appear on any reproductions of the documentation.

Should future revisions of this manual be published, you can acquire printed versions by contacting your Datalogic representative. Electronic versions may either be downloadable from the Datalogic website ([www.datalogic.com](http://www.datalogic.com)) or provided on appropriate media. If you visit our website and would like to make comments or suggestions about this or other Datalogic publications, please let us know via the "Contact Datalogic" page.

**Disclaimer**

Datalogic has taken reasonable measures to provide information in this manual that is complete and accurate, however, Datalogic reserves the right to change any specification at any time without prior notice.

Datalogic and the Datalogic logo are registered trademarks of Datalogic S.p.A. in many countries, including the U.S.A. and the E.U. All other brand and product names may be trademarks of their respective owners.

QuickScan is a registered trademark of Datalogic ADC, Inc. in many countries, including the U.S.A. and the E.U. Autosense is a registered trademark of Datalogic ADC, Inc. in the U.S.

This product may be covered by one or more of the following patents:

D606544 ■ EP870761

Additional patents pending.

# Table of Contents

<b>Chapter 1. Introduction.....</b>	<b>1</b>
About this Guide .....	1
Manual Overview .....	1
Manual Conventions .....	2
References .....	3
Technical Support .....	3
Datalogic Website Support .....	3
Reseller Technical Support .....	3
Telephone Technical Support .....	3
<b>Chapter 2. Getting Started .....</b>	<b>5</b>
About the Scanner .....	5
Unpacking .....	5
Setting Up the Scanner .....	6
Installing the Interface Cable .....	6
Removing the Interface Cable .....	7
Connecting Power (if required) .....	7
Configuring the Scanner .....	7
<b>Chapter 3. Operation.....</b>	<b>9</b>
Nomenclature .....	9
LED and Beeper Indications .....	10
Scan Mode .....	11
Scanning .....	12
Aiming .....	12
Depth of Field .....	14
Maintenance .....	14
<b>Chapter 4. Problem Isolation .....</b>	<b>15</b>
Problem Isolation .....	15
<b>Chapter 5. General Features.....</b>	<b>19</b>
User Preferences .....	19
Scanning Sequence Examples .....	19
Errors While Scanning .....	19
User General Feature Defaults .....	20
Default Parameters .....	21
Restore Defaults .....	21
Beeper Tone .....	22
Beeper Volume .....	22
Power Mode .....	23
Scan Mode .....	23
Stand Mode Timeout Period .....	24
Scan Line Width .....	25
Laser On Time .....	25
Beep After Good Read .....	26
Transmit Label ID .....	26
Prefix/Suffix Values .....	27
Global Prefix/Suffix .....	28
FN1 Substitution Values .....	30
Transmit "No Read" Message .....	30

<b>Chapter 6. RS-232 .....</b>	<b>31</b>
Introduction .....	31
Connecting an RS-232 Interface .....	32
RS-232 Parameter Defaults .....	33
RS-232 Host Parameters .....	33
RS-232 Host Types .....	36
Baud Rate .....	37
Parity .....	38
Stop Bit Select .....	39
Data Bits (ASCII Format) .....	39
Check Receive Errors .....	40
Hardware Handshaking .....	41
Software Handshaking .....	43
Host Serial Response Time-out .....	45
RTS Line State .....	46
Beep on <BEL> .....	46
Intercharacter Delay .....	47
Nixdorf Beep/LED Options .....	48
Ignore Unknown Characters .....	48
ASCII Character Set for RS-232 .....	49
<b>Chapter 7. Keyboard Wedge Interface .....</b>	<b>55</b>
Connecting a Keyboard Wedge Interface .....	55
Keyboard Wedge Parameter Defaults .....	56
Keyboard Wedge Host Parameters .....	57
Keyboard Wedge Host Types .....	57
Keyboard Wedge Country Types (Country Codes) .....	58
Ignore Unknown Characters .....	59
Keystroke Delay .....	60
Intra-Keystroke Delay .....	60
Alternate Numeric Keypad Emulation .....	61
Caps Lock On .....	61
Caps Lock Override .....	62
Convert Wedge Data .....	62
Function Key Mapping .....	63
FN1 Substitution .....	63
Send Make and Break .....	63
Keyboard Maps .....	64
ASCII Character Set for Keyboard Wedge .....	64
<b>Chapter 8. USB Interface .....</b>	<b>75</b>
Connecting a USB Interface .....	75
USB Parameter Defaults .....	76
USB Host Parameters .....	77
USB Device Type .....	77
USB Country Keyboard Types (Country Codes) .....	78
USB Keystroke Delay .....	80
USB CAPS Lock Override .....	80
USB Ignore Unknown Characters .....	81
Emulate Keypad .....	81
USB Keyboard FN 1 Substitution .....	82
Function Key Mapping .....	82
Simulated Caps Lock .....	83
Convert Case .....	83
ASCII Character Set for USB .....	84
<b>Chapter 9. Symbologies .....</b>	<b>95</b>
Introduction .....	95
Scanning Sequence Examples .....	95

Errors While Scanning .....	95
Symbology Parameter Defaults .....	96
UPC/EAN .....	99
Enable/Disable UPC-A/UPC-E .....	99
Enable/Disable UPC-E1 .....	100
Enable/Disable EAN-13/EAN-8 .....	101
Enable/Disable Bookland EAN .....	101
Decode UPC/EAN/JAN Supplementals .....	102
UPC/EAN/JAN Supplemental Redundancy .....	104
Transmit UPC-A Check Digit .....	104
Transmit UPC-E Check Digit .....	105
Transmit UPC-E1 Check Digit .....	105
UPC-A Preamble .....	106
UPC-E Preamble .....	107
UPC-E1 Preamble .....	108
Convert UPC-E to UPC-A .....	109
Convert UPC-E1 to UPC-A .....	109
EAN-8/JAN-8 Extend .....	110
UCC Coupon Extended Code .....	110
Code 128 .....	111
Enable/Disable Code 128 .....	111
Enable/Disable UCC/EAN-128 .....	111
Enable/Disable ISBT 128 .....	112
Code 39 .....	112
Enable/Disable Code 39 .....	112
Enable/Disable Trioptic Code 39 .....	113
Convert Code 39 to Code 32 .....	113
Code 32 Prefix .....	114
Set Lengths for Code 39 .....	114
Code 39 Check Digit Verification .....	116
Transmit Code 39 Check Digit .....	116
Code 39 Full ASCII Conversion .....	117
Code 39 Buffering (Scan & Store) .....	118
Code 93 .....	120
Enable/Disable Code 93 .....	120
Set Lengths for Code 93 .....	121
Code 11 .....	122
Set Lengths for Code 11 .....	123
Code 11 Check Digit Verification .....	125
Transmit Code 11 Check Digits .....	126
Interleaved 2 of 5 (ITF) .....	126
Enable/Disable Interleaved 2 of 5 .....	126
Set Lengths for Interleaved 2 of 5 .....	127
I 2 of 5 Check Digit Verification .....	129
Transmit I 2 of 5 Check Digit .....	129
Convert I 2 of 5 to EAN-13 .....	130
Discrete 2 of 5 (DTF) .....	130
Enable/Disable Discrete 2 of 5 .....	130
Set Lengths for Discrete 2 of 5 .....	131
Chinese 2 of 5 .....	132
Enable/Disable Chinese 2 of 5 .....	132
Codabar (NW - 7) .....	133
Enable/Disable Codabar .....	133
Set Lengths for Codabar .....	133
CLSI Editing .....	135
NOTIS Editing .....	136
MSI .....	136
Enable/Disable MSI .....	136
Set Lengths for MSI .....	137
MSI Check Digits .....	138

Transmit MSI Check Digit(s) .....	139
MSI Check Digit Algorithm .....	139
GS1 DataBar (RSS) .....	140
Convert DataBar to UPC/EAN .....	141
Symbology - Specific Security Levels .....	142
Redundancy Level .....	142
Security Level .....	144
Symbology - Intercharacter Gap .....	146
<b>Appendix A. Technical Specifications .....</b>	<b>147</b>
Standard Cable Pinouts .....	149
<b>Appendix B. Standard Defaults .....</b>	<b>151</b>
<b>Appendix C. Programming Reference.....</b>	<b>157</b>
Datalogic Label ID Identifiers .....	157
AIM Label ID Identifiers .....	157
<b>Appendix D. Sample Bar Codes .....</b>	<b>161</b>
UPC/EAN .....	161
UPC-A, 100% .....	161
EAN-13, 100% .....	161
Code 128 .....	161
Code 39 .....	162
Code 93 .....	162
Code 11 .....	162
Interleaved 2 of 5 .....	162
Discrete 2 of 5 (DTF) .....	163
Chinese 2 of 5 .....	163
Codabar .....	163
MSI .....	163
DataBar (RSS) .....	164
DataBar Omnidirectional .....	164
<b>Appendix E. Keypad .....</b>	<b>165</b>
Cancel .....	166
<b>Appendix F. ASCII Character Sets.....</b>	<b>167</b>
<b>Appendix G. RS-232 Host Commands.....</b>	<b>179</b>
<b>Index .....</b>	<b>181</b>

# Chapter 1

## Introduction

---

### About this Guide

This manual presents advanced user information which includes connection, programming, maintenance, technical specifications, and other useful references. For additional user information, see the Quick Reference Guide (QRG). Copies of other publications for this product are downloadable free of charge from the website listed on the back cover of this manual.

On leaving the factory, units are generally programmed for the most common terminal and communications settings. If you need to change these settings, custom programming can be accomplished by scanning the bar codes in this guide.

### Manual Overview

[Chapter 1, Introduction](#) provides a product overview, unpacking instructions, and cable connection information.

[Chapter 2, Getting Started](#) presents information about unpacking and setting up the scanner.

[Chapter 3, Operation](#) describes parts of the scanner, beeper and LED definitions, and how to use the scanner in Trigger Single and Stand modes.

[Chapter 4, Problem Isolation](#) outlines troubleshooting procedures addressing various problems.

[Chapter 5, General Features](#) includes programming bar codes for selecting common features for the scanner and general use bar codes to customize how the data is transmitted to the host device.

[Chapter 6, RS-232](#) supplies information about setting up the scanner for RS-232 operation.

[Chapter 7, Keyboard Wedge Interface](#) discusses how to set up the scanner for Keyboard Wedge operation.

[Chapter 8, USB Interface](#) explains how to set up the scanner for USB operation.

[Chapter 9, Symbologies](#) defines options for all symbologies and provides the programming bar codes necessary for configuring these features.

[Appendix A, Technical Specifications](#) lists physical and performance characteristics, as well as environmental and regulatory specifications. It also provides standard cable pin-outs.

[Appendix B, Standard Defaults](#) references common factory default settings for scanner features and options.

[Appendix C, Programming Reference](#) is a listing of AIM code identifiers, ASCII character conversions and keyboard maps.

[Appendix D, Sample Bar Codes](#) offers sample bar codes of several common symbolologies.

[Appendix E, Keypad](#) includes numeric bar codes to be scanned for certain parameter settings.

[Appendix F, ASCII Character Sets](#) provides ASCII character value tables.

[Appendix G, RS-232 Host Commands](#) lists host commands the scanner will respond to when in RS-232 interface mode.

## Manual Conventions

The following conventions are used in this document:

*Italics* are used to highlight the following:

- Chapters and sections in this and related documents
- Dialog box, window and screen names
- Drop-down list and list box names.

**Bold** text is used to highlight the following:

- Key names on a keypad.

Bullets (•) indicate:

- Action items
- Lists of alternatives
- Lists of required steps that are not necessarily sequential

Sequential lists (e.g., those that describe step-by-step procedures) appear as numbered lists.

Throughout the programming bar code menus, asterisks (\*) are used to denote default parameter settings.



\* Indicates

\*Baud Rate 9600

Feature/Option



The symbols listed below are used in this manual to notify the reader of key issues or procedures that must be observed when using the scanner:

**NOTE**

Notes contain information necessary for properly diagnosing, repairing and operating the scanner.

**CAUTION**

The CAUTION symbol advises you of actions that could damage equipment or property.

## References

Current versions of the Product Reference Guide (PRG), Quick Reference Guide (QRG), and any other manuals and instruction sheets for this product can be downloaded from the website listed on the back cover of this manual. Alternatively, printed copies or product support CDs can be purchased through your Datalogic reseller.

## Technical Support

### Datalogic Website Support

The Datalogic website ([www.scanning.datalogic.com](http://www.scanning.datalogic.com)) is the complete source for technical support and information for Datalogic products. The site offers product support, product registration, warranty information, product manuals, product tech notes, software updates, demos, and instructions for returning products for repair.

### Reseller Technical Support

An excellent source for technical assistance and information is an authorized Datalogic reseller. A reseller is acquainted with specific types of businesses, application software, and computer systems and can provide individualized assistance.

### Telephone Technical Support

If you do not have internet or email access, you may contact Datalogic technical support at (541) 349-8283 or check the back cover of your manual for more contact information.

# NOTES

# Chapter 2

## Getting Started

### About the Scanner

The scanner combines excellent scanning performance and advanced ergonomics to provide the best value in a lightweight laser scanner. Whether used in Trigger Single or Stand mode, the scanner ensures comfort and ease of use for extended periods of time.



**This scanner does not support PDF417 bar codes and its variants.**

#### NOTE

This scanner supports the following interfaces:

- Keyboard Wedge connection to a host. The host interprets scanned data as keystrokes. This interface supports the following international keyboards (for Windows® environment): North America, German, French, French Canadian, Spanish, Italian, Swedish, UK English, Portuguese-Brazilian, and Japanese.
- Standard RS-232 connection to a host. Scan bar code menus to set up proper communication of the scanner with the host.



**The scanner uses TTL RS-232 signal levels, which will interface with most system architectures.**

#### NOTE

- USB connection to a host. The scanner autodetects a USB host and defaults to the HID keyboard interface type. Select other USB interface types by scanning programming bar code menus. This interface supports the following international keyboards (for Windows® environment): North America, German, French, French Canadian, Spanish, Italian, Swedish, UK English, Portuguese-Brazilian, and Japanese.

### Unpacking

Verify that the scanner and any accessories are what were ordered and that they are undamaged. If any damage occurred in transit, contact [Technical Support on page 3](#).

KEEP THE PACKAGING. Should the unit ever require service, it should be returned in its original shipping container.

# Setting Up the Scanner

## Installing the Interface Cable

To connect the interface cable:

1. Insert the interface cable's modular connector clip into the cable interface port on the bottom of the scanner handle. (See [Figure 1](#)).
2. Gently tug the cable to ensure the connector is properly secured.
3. Connect the other end of the interface cable to the host. (See the specific host chapter for information on host connections.)

**Figure 1. Connecting the Interface Cable**

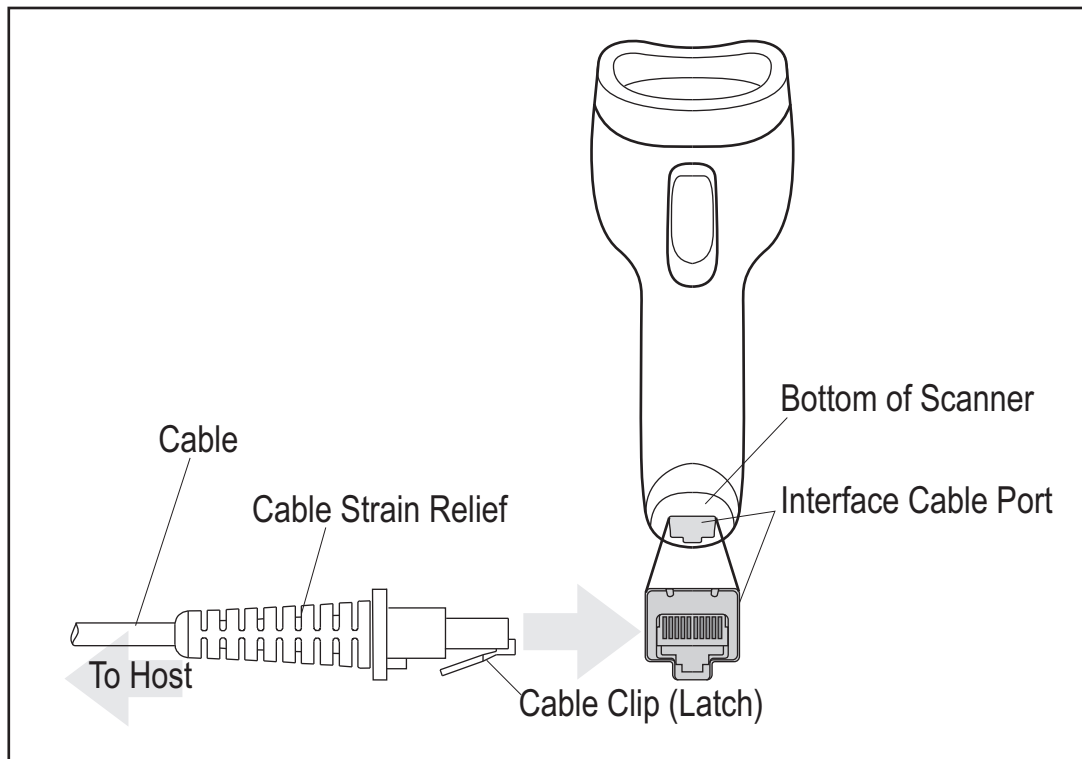

**NOTE**

Specific cables are required for connection to different hosts. The connectors illustrated in each host chapter are examples only. Actual connectors may vary from those illustrated, but the steps to connect the scanner remain the same.

## Removing the Interface Cable

To remove the Interface Cable:

1. Unlatch the installed cable modular connector by depressing the connector clip with the end of a paper clip as shown in [Figure 2](#).

**Figure 2. Releasing the Cable Latch**

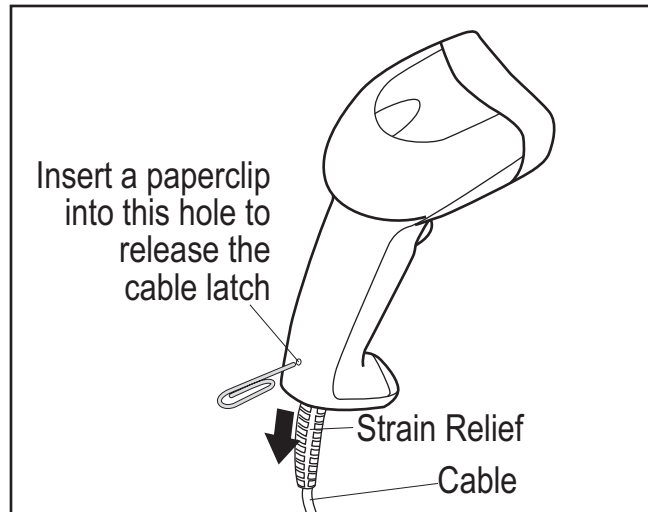

2. Carefully slide out the cable.
3. Follow the steps in the previous section, [Installing the Interface Cable](#), to connect a new cable.

## Connecting Power (if required)

If the host does not provide power to the scanner, an external power connection to the scanner is required. To connect power:

1. Connect the interface cable to the bottom of the scanner, as previously described in the section, [Installing the Interface Cable](#).
2. Connect the other end of the interface cable to the host (refer to the host manual to locate the correct port).
3. Plug the power supply into the power jack on the interface cable. Plug the other end of the power supply into an AC outlet.

## Configuring the Scanner

To configure the scanner, use the bar codes included in this manual.

See [Chapter 5, General Features](#) and [Chapter 9, Symbologies](#) for information about programming the scanner using bar code menus. Also see each host-specific chapter to set up a connection to a specific host type.

# NOTES

# Chapter 3

## Operation

This chapter provides beeper and LED definitions, techniques involved in scanning bar codes, general instructions and tips about scanning, and decode zone diagrams.

### Nomenclature

Nomenclature for physical features on the scanner is shown in [Figure 3](#).

**Figure 3. Nomenclature**

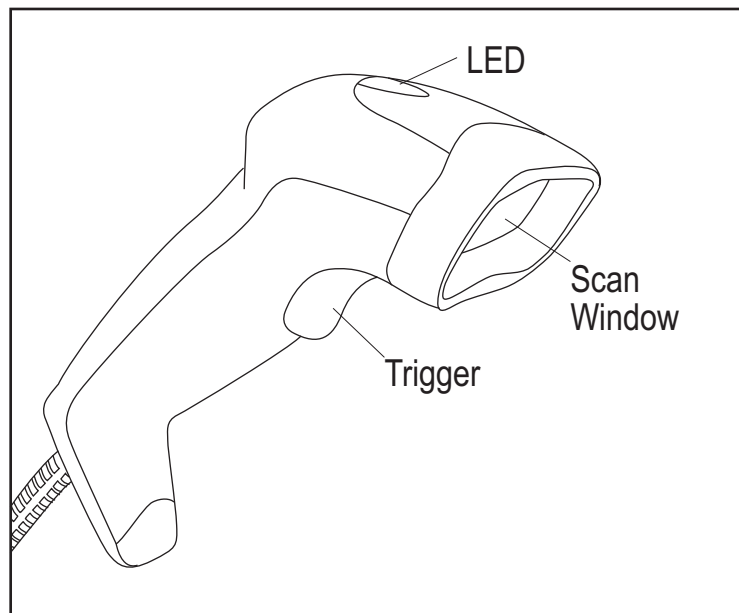

## LED and Beeper Indications

The scanner's beeper sounds and its two-color LED illuminates to indicate various functions or errors on the scanner. The tables below list these indications. One exception to the behaviors listed in the tables is that the scanner's functions are programmable, and may or may not be turned on. For example, certain indications, such as the power-up beep can be disabled using programming bar code labels.

**Table 1. Beeper Functions**

Beeper Sequence	Indication
<b>Standard Use</b>	
Low/medium/high beeps	Power up.
Short high beeps	A bar code label was decoded (if decode beeper is enabled).
4 long low beeps	A transmission error was detected in a scanned bar code. The data is ignored. This occurs if a unit is not properly configured. Check option setting.
5 low beeps	Conversion or format error.
Low/high/low beeps	Advanced Data Formatting (ADF) transmit error. (For information about ADF programming, refer to <a href="#">Technical Support</a> .)
High/high/high/low beeps	RS-232 receive error.
<b>Parameter Menu Scanning</b>	
Short high beeps	Correct entry scanned or correct menu sequence performed.
Low/high beeps	Input error, incorrect bar code or "Cancel" scanned, wrong entry, incorrect bar code programming sequence; remain in Programming Mode.
High/low beeps	Keyboard parameter selected. Enter value using bar code keypad.
High/low/high/low beeps	Successful program exit with change in the parameter setting.
Low/high/low/high beeps	Out of host parameter storage space. Scan <a href="#">Default Parameters on page 21</a> .
<b>Code 39 Buffering</b>	
High/low beeps	New Code 39 data was entered into the buffer.
3 Beeps - long high beeps	Code 39 buffer is full.
Low/high/low beeps	The Code 39 buffer was erased or there was an attempt to clear or transmit an empty buffer.
Low/high beeps	A successful transmission of buffered data.
<b>Host Specific</b>	
<b>USB Only</b>	



**Table 1. Beeper Functions**

Beeper Sequence	Indication
4 short high beeps	Scanner has not completed initialization. Wait several seconds and scan again.
Scanner gives a power-up beep after scanning a USB Device Type.	Communication with the bus must be established before the scanner can operate at the highest power level.
This power-up beep occurs more than once.	The USB bus may put the scanner in a state where power to the scanner is cycled on and off more than once. This is normal and usually happens when the host cold boots.
<b>RS-232 Only</b>	
1 short high beep	A <BEL> character is received and Beep on <BEL> is enabled.

**Table 2. LED Indications**

LED Sequence	Indication
Off	No power is applied to the scanner, or the scanner is on and ready to scan.
Green	A bar code was successfully decoded.
Red	A data transmission error or scanner malfunction occurred.

## Scan Mode

The scanner can be configured to be active in one of two Scan Modes:

**Trigger Single Mode** — the trigger button must be pressed to scan a bar code.

**Stand Mode** — the scanner continuously reads regardless of whether the trigger is pressed



### NOTE

When the scanner is not used for an extended period of time in Stand Mode, it enters Sleep Mode. To wake the scanner, press the trigger button.

To toggle between these modes, see [Scan Mode on page 23](#).

## Scanning

To scan a bar code:

1. Install and program the scanner (See “Setting Up the Scanner” on page 6.). For assistance, contact [Technical Support](#).
2. Ensure all connections are secure. (See the host chapter for the scanner.)
3. Aim the scanner at the bar code.
4. If the scanner is in Trigger Single Mode, press the trigger button. (In Stand Mode, no trigger button press is required. The scanner laser is in constant ON mode.)

**Figure 4. Scanning With/Without the Trigger**

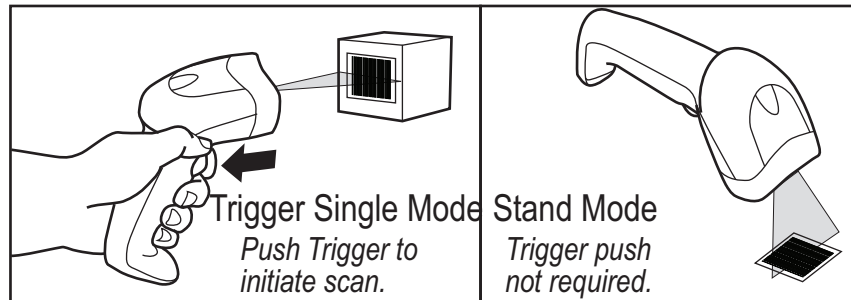

5. Upon successful decode, the scanner beeps and the LED flashes green. (For more information about beeper and LED definitions, see [Table 1](#) and [Table 2](#).)



**NOTE**

The width of the scan line is dependent upon the current setting for the programmable feature, Scan Line Width. “Full” (the default setting) or “Medium” scan line widths are available.

## Aiming

For a typical, full-sized UPC label, the scanner should be held between 1” and 7” from the bar code. Ensure that the scan line crosses the entire bar code as shown in [Figure 5](#).

**Figure 5. Correct and Incorrect Aiming**

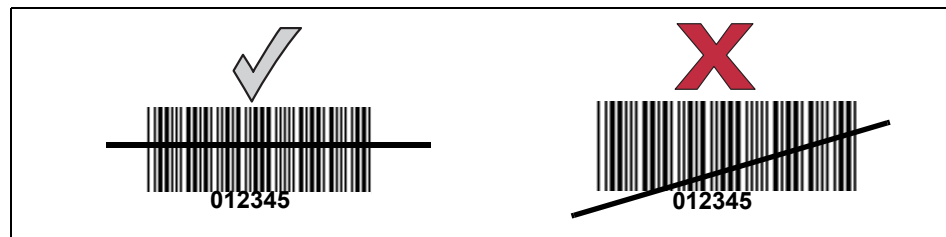

The scan line is smaller when the scanner is closer to the bar code and grows when the scanner is drawn away from the bar code. For best results, hold the scanner closer to bar codes with very small bars or elements (mil size) and pull the scanner further away from labels having larger bars or elements (mil size).

Do not hold the scanner perpendicular to the bar code when scanning. Laser light reflecting directly back into the scanner from the bar code can result in specular reflection, which can in turn cause difficulties with decoding. Tilt the scanner to avoid the dead zone (indicated by an 'X' in [Figure 6](#)) up to 65 degrees upwards or downwards.

**Figure 6. Aiming to Avoid the Dead Zone**

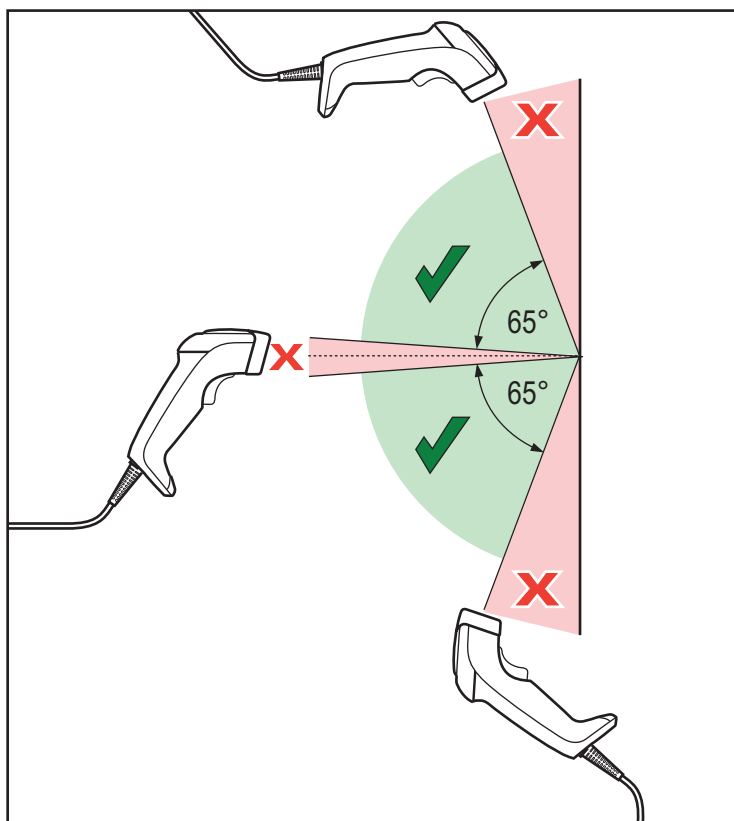

# Depth of Field

Figure 7 shows the zone in which bar codes are read by the scanner.

**Figure 7. Depth of Field Chart**

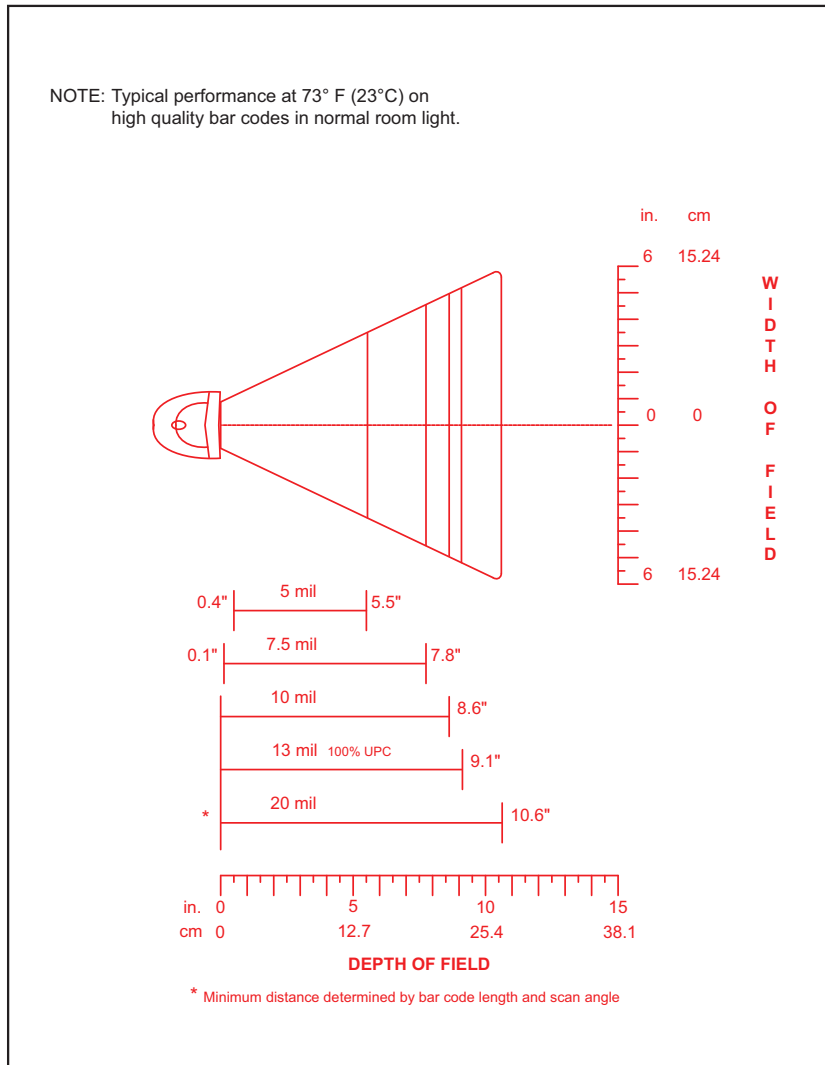

## Maintenance

Periodic cleaning of the scan window is the only maintenance required. A dirty window may affect scanning ability.

- Do not allow any abrasive material to touch the scanner.
- Remove any dirt particles with a soft, lint-free cloth lightly dampened with water.
- Gently wipe the window using a lens tissue moistened with ammonia/water.
- Do not spray water or other cleaning liquids directly onto the scanner or window.
- If the scan window becomes scratched, broken or contaminated with heavy dust, replace with a new window, which is available as an orderable accessory.

# Chapter 4

## Problem Isolation

This chapter provides troubleshooting information, technical specifications, and signal descriptions (pinouts).

### Problem Isolation

Table 3 provides problem/remedy information for use in troubleshooting scanner functions.

**Table 3. Troubleshooting**

Problem	Possible Causes	Possible Solutions
<b>Beeper Indications (Also see LED and Beeper Indications on page 10)</b>		
Scanner emits frequent beeps. (USB host interface only.)	The USB bus may put the scanner in a state where power to the scanner is cycled on and off more than once.	This is normal and usually happens when the host cold boots.
Scanner emits low/high/low beeps.	ADF transmit error.	Refer to the Advanced Data Formatting Programmer's Guide for information about ADF programming.
	Invalid ADF rule is detected.	
Scanner emits low/high beeps.	Input error, incorrect bar code or <b>Cancel</b> bar code was scanned.	Scan the correct numeric bar codes within range for the parameter programmed.
Scanner emits low/high/low beeps.	The Code 39 buffer was erased or there was an attempt to clear or transmit an empty buffer.	Normal when scanning the Code 39 Buffering <b>Clear Buffer</b> bar code or upon attempt to transmit an empty Code 39 buffer.
Scanner emits low/high/low/high beeps.	Out of host parameter storage space.	Scan <a href="#">Default Parameters on page 21</a> .
	Out of memory for ADF rules.	Reduce the number of ADF rules or the number of steps in the ADF rules.
Scanner emits high/low beeps.	The scanner is buffering Code 39 data.	Normal.
Scanner emits high/high/high/low beeps.	RS-232 receive error.	Normal during host reset. Otherwise, set the scanner's RS-232 parity to match the host setting.
Scanner emits four long low beeps.	A transmission error was detected in a scanned bar code. The data is ignored.	This occurs if a unit is not properly configured. Verify programmed options.
Scanner emits four short high beeps (USB only).	Scanner has not completed initialization.	Wait several seconds and scan again.

Problem	Possible Causes	Possible Solutions
Scanner emits a short low/high/low/high beep sequence while it is being programmed.	Out of ADF parameter storage space.	Erase all rules and re-program with shorter rules.
<b>Decoding Bar Codes</b>		
Scanner emits laser light, but does not decode the bar code.	Scanner is not programmed for the correct bar code type.	Program the scanner to read that type of bar code. See <a href="#">Chapter 9, Symbologies</a> .
	Bar code is unreadable.	Scan other samples of the same bar code type to determine if the bar code is defaced.
	Distance between scanner and bar code is incorrect.	Move the scanner closer to or further from the bar code. See <a href="#">Depth of Field on page 14</a> .
	The scan line is not crossing every bar and space of the bar code.	Move the bar code until the scan line is within the acceptable aiming pattern. See <a href="#">Figure 5</a> .
Scanner decodes bar code, but does not transmit the data to the host.	Scanner is not programmed for the correct host type.	Scan the appropriate host type programming bar code. See the chapter corresponding to the host type.
	Interface cable is loose.	Check for loose cable connection and re-connect cable.
Scanner emits five long low beeps after a bar code is decoded.	Conversion or format error was detected. The scanner's conversion parameters are not properly configured.	Ensure the scanner's conversion parameters are properly configured.
	Conversion or format error was detected. An ADF rule was set up with characters that can't be sent for the host selected.	Change the ADF rule, or change to a host that can support the ADF rule.
	Conversion or format error was detected. A bar code was scanned with characters that can't be sent for that host.	Change the bar code, or change to a host that can support the bar code.

Problem	Possible Causes	Possible Solutions
<b>Host Error</b>		
Host displays scanned data incorrectly.	Scanner is not programmed to work with the host.	Ensure the proper host is selected.
		Scan the appropriate host type programming bar code.
		For RS-232, set the scanner's communication parameters to match the host's settings.
		For a USB HID keyboard or Keyboard Wedge configuration, program the system for the correct keyboard type and language, and turn off the CAPS LOCK key.
		Program the proper editing options (e.g., ADF, UPC-E to UPC-A Conversion).
Check the scanner's host type parameters or editing options.		
<b>Trigger</b>		
Nothing happens when the trigger button is pressed.	No power to the scanner.	Verify that system power is sufficient. If the scanner requires a power supply, reconnect using an approved power supply.
	Interface/power cables are loose.	Check for loose cable connections and reconnect cables.
	Incorrect host interface cable is used.	Verify that the correct host interface cable is used. If not, connect the correct host interface cable.



**NOTE**

If the problem persists after performing these checks, contact your distributor or [Technical Support](#).

# NOTES



# Chapter 5

## General Features

### User Preferences

User preferences for the general features listed in this chapter can be selected using the programming bar codes that accompany each feature description. To set feature values, scan a single programming bar code or a short bar code sequence as instructed for each feature. The settings are stored in non-volatile memory and are preserved even when the scanner is powered down.

Typically, a scanner ships with the settings shown in [User General Feature Defaults on page 20](#) (also see [Appendix B, Standard Defaults](#) for all host defaults). If the default values suit requirements, programming may not be necessary.

If not using a USB cable, select a host type (see each host chapter for specific host information) after the power-up beeps sound. This is only necessary upon the first power-up when connecting to a new host.

To return all features to their default values, reference the topic, [Return to Factory Defaults](#). Throughout the programming bar code menus, default values are indicated with asterisks (\*).



\* Indicates Default — \*High Frequency — Feature/Option

### Scanning Sequence Examples

In most cases, scanning one bar code sets the parameter value. For example, to set the beeper tone to high, scan the High Frequency (beeper tone) bar code on [page 19](#). The scanner issues a fast warble beep and the LED turns green, signifying a successful parameter entry.

Other parameters, such as Serial Response Time-Out or Data Transmission Formats, require the scanning of a sequence of bar codes. See these parameter descriptions for this procedure.

### Errors While Scanning

Unless otherwise specified, when an error is made during a scanning sequence, just re-scan the correct feature bar code(s).

## User General Feature Defaults

Table 4 lists the factory defaults for the general features described in this chapter, plus provides a place for you to log any special requirements or user-preferred settings at your installation. To change any option, scan the appropriate programming bar code(s) provided in this chapter.



See Appendix B, Standard Defaults for a listing of all programmable features.

### NOTE

**Table 4. General Feature Defaults**

General Feature	Standard Factory Default	Page Number	Record Your Setting
Beeper Tone	Medium	22	
Beeper Volume	High	22	
Power Mode	Continuous On	23	
Scanning Mode	Trigger Single	23	
Scan Line Width	Full Width	25	
Laser On Time	3.0 Sec	25	
Beep After Good Decode	Enable	26	
Transmit Label ID Character	None	26	
Prefix Value	7013 <CR><LF>	27	
Suffix Value	7013 <CR><LF>	27	
Scan Data Transmission Format	Data as is	26	
FN1 Substitution Values	Set	30	
Transmit "No Read" Message	Disable	30	

## Default Parameters

The scanner can be reset using one of two default settings: factory defaults or custom defaults. Scan the appropriate bar code(s) below to reset the scanner to its default settings and/or set the scanner's current settings as the custom default.

**Set Factory Defaults** — Scan the Set Factory Defaults bar code below to eliminate all custom default values and return the scanner to factory default values. (For factory default values, see [Appendix B, Standard Defaults](#).)

**Write to Custom Defaults** — Custom default parameters can be configured to set unique default values for all parameters. After changing all parameters to the desired default values, scan the Write to Custom Defaults bar code below to configure custom defaults.

## Restore Defaults

Resets all default parameters as follows:

- If custom default values were configured (see [Write to Custom Defaults](#) above), the custom default values are set for all parameters each time the Restore Defaults bar code below is scanned.
- If no custom default values were configured, the factory default values are set for all parameters each time the Restore Defaults bar code below is scanned. (For factory default values, see [Appendix B, Standard Defaults](#).)



**Set Factory Defaults**



**Write to Custom Defaults**



**\*Restore Defaults**

## Beeper Tone

To select a decode beep frequency (tone), scan the Low Frequency, Medium Frequency, or High Frequency bar code.

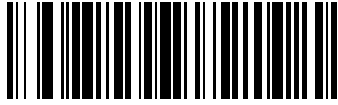

Low Frequency



\*Medium Frequency  
(Optimum Settings)

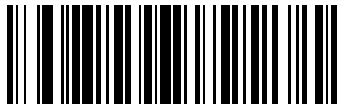

High Frequency

## Beeper Volume

To select a beeper volume, scan the Low Volume, Medium Volume, or High Volume bar code.



Low Volume



Medium Volume



\*High Volume

## Power Mode

This parameter determines whether or not power remains on after a decode attempt. When in reduced power mode, the scanner enters low power consumption mode after each decode. When in continuous power mode, power remains on after each decode.



\*Continuous On



Reduced Power Mode

## Scan Mode

This parameter determines whether the scanner is in *Trigger Single Mode* or *Stand Mode*. In *Trigger Single Mode*, the scanner trigger button must be pressed to decode each scanned bar code. In *Stand Mode*, the scanner laser is in constant ON state and no trigger button press is required to scan a bar code.

Depending upon which mode the scanner currently is in, scan the “Toggle Scan Mode” to switch from *Trigger Single* to *Stand Mode*, or from *Stand Mode* to *Trigger Single Mode*. The standard default setting for this feature is *Trigger Single Mode*.

While in the *Stand Mode* of operation, if the scanner has not been used for several minutes it will shift to low power operation, signalled by a narrowing of the scanning beam. When in low power mode, the scanner will respond to a barcode and come back to normal *Stand Mode* operation upon seeing/reading the label.

If the scanner has been idle for an extended configurable period<sup>1</sup>, it will timeout, then enter sleep mode with the scanning beam turned off. To wake the scanner from sleep mode, press the trigger button.



\*Toggle Scan Mode

1. See the following topic [Stand Mode Timeout Period](#).

## Stand Mode Timeout Period

The Timeout Period for the transition from low power to sleep mode can be set to one of the following durations:

- 1 Hour
- 5 Hours (default)
- Infinite Timeout — With this setting, there is no timeout, thus the scanner will never go into sleep mode or beam shut-off but will remain in low power mode until a label is read.

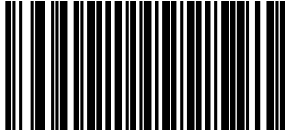

**Stand Mode Timeout Period = 1 Hour**

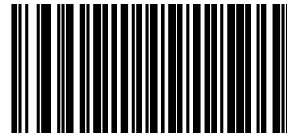

**\*Stand Mode Timeout Period = 5 Hours**

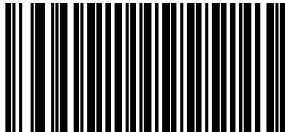

**Stand Mode Timeout Period = Infinite Timeout**

## Scan Line Width

Scan a bar code below to set the scan line width. A full scan line width is the default. The medium scan line width is useful for scanning menus or pick-lists.



This feature applies to scanners in Trigger Single Mode only.

NOTE



\*Full Width



Medium Width

## Laser On Time

This parameter sets the maximum time that decode processing continues during a scan attempt. It is programmable in 0.1 second increments from 0.5 to 9.9 seconds. The default Laser On Time is 3.0 seconds.

To set a Laser On Time, scan the bar code below. Next, scan the two numeric bar codes from [Appendix E, Keypad](#), that correspond to the desired On Time. Single digit numbers must be padded with a leading zero. For example, to set an On Time of 0.5 seconds, scan the bar code below, then scan the “0” and “5” bar codes. If an error is made, or the selection needs to be changed, scan [Cancel on page 166](#).



This feature applies to scanners in Trigger Single Mode only.

NOTE



Laser On Time

## Beep After Good Read

Scan a bar code below to select whether or not the scanner should beep after a good read. If Do Not Beep After Good Read is selected, the beeper still operates during parameter menu scanning and indicates error conditions.



**\*Beep After Good Read  
(Enable)**

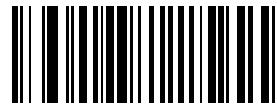

**Do Not Beep After Good Read  
(Disable)**

## Transmit Label ID

Label ID characters identify the code (symbology) type of a scanned bar code. This may be useful when the scanner is decoding more than one code type. In addition to any single character prefix already selected, the Label ID character is inserted between the prefix and the decoded bar code.

Select no Label ID character, a Datalogic Label ID, or an AIM Label ID. For a listing of Label ID Characters, see [Datalogic Label ID Identifiers on page 157](#) and [AIM Label ID Identifiers on page 157](#).

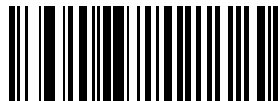

**Datalogic Label ID**



**AIM Label ID**



**\*No Label ID**



## Prefix/Suffix Values

A prefix and/or suffix can be appended to scan data for use in data editing as described in the feature description, [Global Prefix/Suffix on page 28](#).

To set a value for a prefix or suffix:

1. Change the scan data format using the instructions in the feature description, [Global Prefix/Suffix on page 28](#).
2. Scan the appropriate prefix/suffix bar code below.
3. Scan a four-digit number (i.e., four bar codes from [Appendix E, Keypad](#)) that corresponds to that value.



### NOTE

When using host commands to set the prefix or suffix, set the key category parameter to 1, then set the 3-digit decimal value corresponding to the desired keystroke as listed in [Table 34 on page 167](#) (results in a four-digit ASCII code).

4. To correct an error or change a selection, scan [Data Format Cancel on page 29](#).

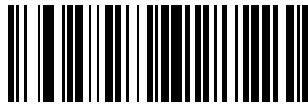

**Set Prefix**



**Set Suffix**

## Global Prefix/Suffix

ASCII characters may be added as a prefix (in a position before the bar code data) and/or as a suffix (in a position following the bar code data). Scan the bar code below labeled “Scan Options”, then one of the following four bar codes corresponding to the position(s) you wish to specify:

- Data As Is
- <DATA> <SUFFIX>
- <PREFIX> <DATA>
- <PREFIX> <DATA> <SUFFIX>.

Scan the “Enter” bar code to complete the change. To set values for the prefix and/or suffix, [See Prefix/Suffix Values on page 27](#). Scan the bar code “Data Format Cancel” if you wish to cancel the change.

If a carriage return/enter is required after each scanned bar code, scan the following bar codes in order:

1. “Scan Options”
2. <DATA> <SUFFIX>
3. “Enter”

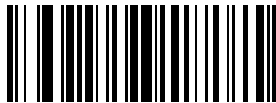

Scan Options



\*Data As Is

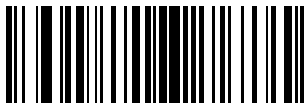

<DATA> <SUFFIX>

## Global Prefix/Suffix – continued



<PREFIX> <DATA>



<PREFIX> <DATA> <SUFFIX>



Enter



Data Format Cancel

## FN1 Substitution Values

The Wedge and USB HID Keyboard hosts support an FN1 substitution feature. When enabled, any FN1 character (0x1b) in an EAN128 bar code is substituted with a value. This value defaults to 7013 (Enter Key).

To select an FN1 substitution value via bar code menus:

1. Scan the bar code below.



**\*Set FN1 Substitution Value**

2. Look up the keystroke desired for FN1 Substitution in [Appendix F, ASCII Character Sets](#) for the currently installed host interface.

3. Enter the 4-digit substitution value by scanning each digit in [Appendix E, Keypad](#).

To correct an error or change the selection, scan Cancel.

To enable FN1 substitution for keyboard wedge, scan the [Enable FN1 Substitution on page 63](#).

To enable FN1 Substitution for USB HID keyboard, scan the [Enable FN1 Substitution on page 82](#).

## Transmit "No Read" Message

Scan a bar code below to select whether or not to transmit a No Read message. When enabled, the characters NR are transmitted when a bar code is not decoded. When disabled, if a bar code does not decode, nothing is sent to the host.



**Enable No Read**



**\*Disable No Read**

# Chapter 6

## RS-232

### Introduction

This chapter describes how to set up the scanner with an RS-232 host. The RS-232 interface is used to connect the scanner to point-of-sale devices, host computers, or other devices with an available RS-232 port (e.g., com port).

If the host is not listed in [Table 6](#), refer to the documentation for the host device to set communication parameters to match the host.



The scanner uses TTL RS-232 signal levels, which will interface with most system architectures.

#### NOTE

Throughout the programming bar code menus, default values are indicated with asterisks (\*).



\* Indicates Default      \*Baud Rate 57,600      Feature/Option

## Connecting an RS-232 Interface

This connection is made directly from the scanner to the host computer.

**Figure 8. RS-232 Direct Connection**

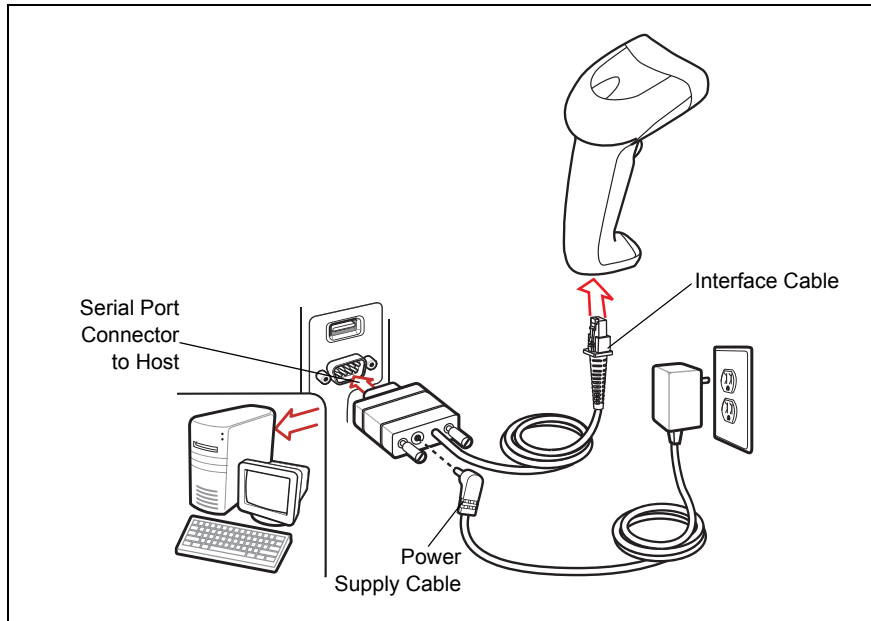

### NOTE

Interface cables vary depending on configuration. The connectors illustrated in [Figure 8](#) are examples only. The connectors may be different than those illustrated, but the steps to connect the scanner remain the same.

1. Attach the modular connector of the RS-232 interface cable to the cable interface port on the scanner (see [Installing the Interface Cable on page 6](#)).
2. Connect the other end of the RS-232 interface cable to the serial port on the host.
3. Connect the power supply<sup>1</sup> to the serial connector end of the RS-232 interface cable. Plug the power supply into an appropriate outlet.
4. Select the RS-232 host type by scanning the appropriate bar code from [RS-232 Host Types on page 36](#).
5. To modify any other parameter options, scan the appropriate bar codes in this chapter.



### NOTE

Refer to [RS-232 Host Commands on page 179](#) for a listing of host commands the scanner will respond to when in RS-232 interface mode.

1. Use only aDatalogic power supply approved for this product.

## RS-232 Parameter Defaults

Table 5 lists the defaults for RS-232 host parameters. If any option needs to be changed, scan the appropriate bar code(s) provided in the Parameter Descriptions section beginning on page 33.



### NOTE

See Appendix B, Standard Defaults for all user preferences, hosts, symbologies, and miscellaneous default parameters.

**Table 5. RS-232 Defaults**

Parameter	Default	Page Number
<b>RS-232 Host Parameters</b>		
RS-232 Host Types	Standard	36
Baud Rate	9600	37
Parity Type	None	38
Stop Bit Select	1 Stop Bit	39
Data Bits (ASCII Format)	8-Bit	39
Check Receive Errors	Enable	40
Hardware Handshaking	None	42
Software Handshaking	None	44
Host Serial Response Time-out	2 Sec	45
RTS Line State	Low RTS	46
Beep on <BEL>	Disable	46
Intercharacter Delay	0 msec	47
Nixdorf Beep/LED Options	Normal Operation	48
Ignore Unknown Characters	Send Bar Code	48

## RS-232 Host Parameters

Various RS-232 hosts are set up with their own parameter default settings (Table 6). Selecting the ICL, Fujitsu, Wincor-Nixdorf Mode A, Wincor-Nixdorf Mode B, Olivetti, Omron, or terminal sets the defaults listed in Table 6.

Selecting the ICL, Fujitsu, Wincor-Nixdorf Mode A, Wincor-Nixdorf Mode B, OPOS terminal enables the transmission of code ID characters listed in Table 7 on page 34.

These code ID characters are not programmable and are separate from the Transmit Code ID feature. The Transmit Code ID feature should not be enabled for these terminals.

**Table 6. Terminal Specific RS-232**

Parameter	Standard (Default)	ICL	Fujitsu	Wincor-Nixdorf Mode A	Wincor-Nixdorf Mode B/OPOS	Olivetti	Omron
Transmit Code ID	No	Yes	Yes	Yes	Yes	Yes	Yes
Data Transmission Format	Data as is	Data/Suffix	Data/Suffix	Data/Suffix	Data/Suffix	Prefix/Data/Suffix	Data/Suffix
Suffix	CR/LF (7013)	CR (1013)	CR (1013)	CR (1013)	CR (1013)	ETX (1002)	CR (1013)
Baud Rate	9600	9600	9600	9600	9600	9600	9600
Parity	None	Even	None	Odd	Odd	Even	None
Hardware Handshaking	None	RTS/CTS Option 3	None	RTS/CTS Option 3	RTS/CTS Option 3	None	None
Software Handshaking	None	None	None	None	None	Ack/Nak	None
Serial Response Time-out	2 Sec.	9.9 Sec.	2 Sec.	9.9 Sec.	9.9 Sec.	9.9 Sec.	9.9 Sec.
Stop Bit Select	One	One	One	One	One	One	One
ASCII Format	8-Bit	8-Bit	8-Bit	8-Bit	8-Bit	7-Bit	8-Bit
Beep On <BEL>	Disable	Disable	Disable	Disable	Disable	Disable	Disable
RTS Line State	Low	High	Low	Low	Low = No data to send	Low	High
Prefix	None	None	None	None	None	STX (1003)	None
*In the Nixdorf Mode B, if CTS is Low, scanning is disabled. When CTS is High, the user can scan bar codes.							
**If Nixdorf Mode B is scanned without the scanner connected to the proper host, it may appear unable to scan. If this happens, scan a different RS-232 host type within 5 seconds of cycling power to the scanner.							

**Table 7. Terminal Specific Code ID Characters**

	ICL	Fujitsu	Wincor-Nixdorf Mode A	Wincor-Nixdorf Mode B/OPOS	Olivetti	Omron
UPC-A	A	A	A	A	A	A
UPC-E	E	E	C	C	C	E
EAN-8/JAN-8	FF	FF	B	B	B	FF

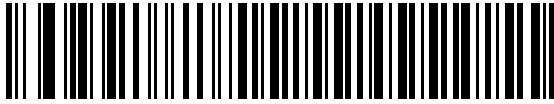

**Table 7. Terminal Specific Code ID Characters**

	ICL	Fujitsu	Wincor-Nixdorf Mode A	Wincor-Nixdorf Mode B/OPOS	Olivetti	Omron
EAN-13/JAN-13	F	F	A	A	A	F
Code 39	C <len>	None	M	M	M <len>	C <len>
Codabar	N <len>	None	N	N	N <len>	N <len>
Code 128	L <len>	None	K	K	K <len>	L <len>
I 2 of 5	I <len>	None	I	I	I <len>	I <len>
Code 93	None	None	L	L	L <len>	None
D 2 of 5	H <len>	None	H	H	H <len>	H <len>
UCC/EAN 128	L <len>	None	P	P	P <len>	L <len>
MSI	None	None	O	O	O <len>	None
Bookland EAN	F	F	A	A	A	F
Trioptic	None	None	None	None	None	None
Code 11	None	None	None	None	None	None
IATA	H<len>	None	H	H	None	None
Code 32	None	None	None	None	None	None

## RS-232 Host Types

To select an RS-232 host interface, scan one of the following bar codes.



**\*Standard RS-232**

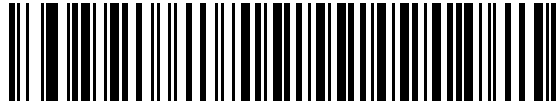

**ICL RS-232**

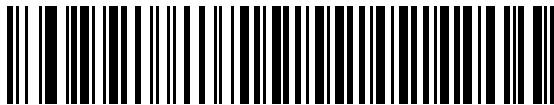

**RS-232 Wincor-Nixdorf Mode A**

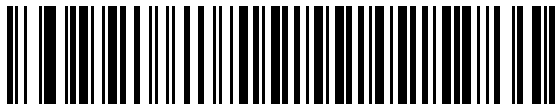

**RS-232 Wincor-Nixdorf Mode B**

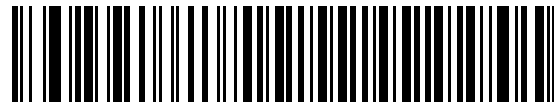

**RS-232 Olivetti ORS4500**



**RS-232 Omron**

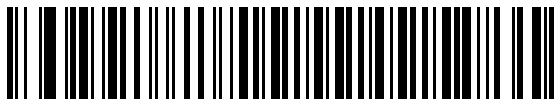

**RS-232 OPOS**



**RS-232 Fujitsu**

## Baud Rate

Baud rate is the number of bits of data transmitted per second. Set the scanner's baud rate to match the baud rate setting of the host device. Otherwise, data may not reach the host device or may reach it in distorted form.



**Baud Rate 600**



**Baud Rate 1200**

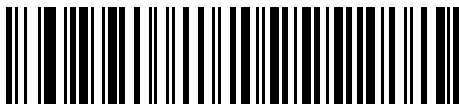

**Baud Rate 2400**



**Baud Rate 4800**

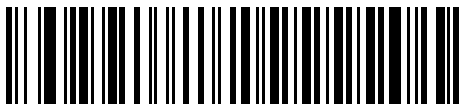

**\* Baud Rate 9600**



**Baud Rate 19,200**

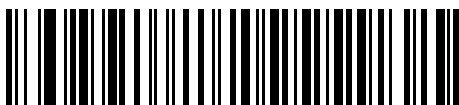

**Baud Rate 38,400**

## Parity

A parity check bit is the most significant bit of each ASCII coded character. Select the parity type according to host device requirements.

- Select Odd parity and the parity bit value is set to 0 or 1, based on data, to ensure that an odd number of 1 bits are contained in the coded character.
- Select Even parity and the parity bit value is set to 0 or 1, based on data, to ensure that an even number of 1 bits are contained in the coded character.
- Select Mark parity and the parity bit is always 1.
- Select Space parity and the parity bit is always 0.
- Select None when no parity bit is required.

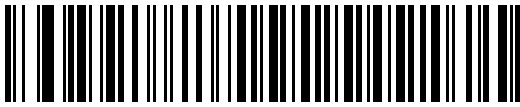

Odd

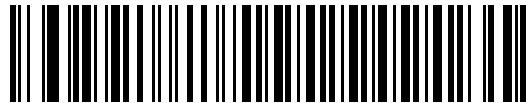

Even

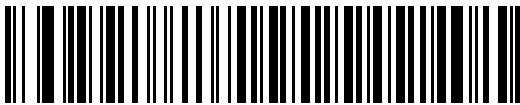

Mark

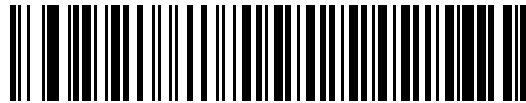

Space

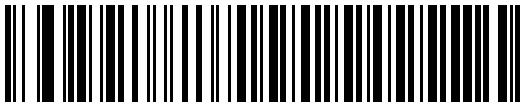

\*None

## Stop Bit Select

The stop bit(s) at the end of each transmitted character marks the end of transmission of one character and prepares the receiving device for the next character in the serial data stream. The number of stop bits selected (one or two) depends on the number the receiving terminal is programmed to accommodate. Set the number of stop bits to match host device requirements.



\*1 Stop Bit



2 Stop Bits

## Data Bits (ASCII Format)

This parameter allows the scanner to interface with devices requiring a 7-bit or 8-bit ASCII protocol.

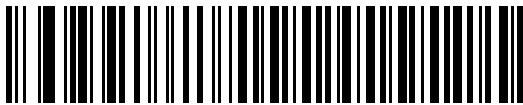

7-Bit



\*8-Bit

## Check Receive Errors

Select whether or not the parity, framing, and overrun of received characters are checked. The parity value of received characters is verified against the parity parameter selected above.



**\*Check For Received Errors  
(Enable)**



**Do Not Check For Received Errors  
(Disable)**

## Hardware Handshaking

The data interface consists of an RS-232 port designed to operate either with or without the hardware handshaking lines, *Request to Send* (RTS), and *Clear to Send* (CTS). If Standard RTS/CTS handshaking is not selected, scan data is transmitted as it becomes available. If Standard RTS/CTS handshaking is selected, scan data is transmitted according to the following sequence:

- The scanner reads the CTS line for activity. If CTS is asserted, the scanner waits up to Host Serial Response Time-out for the host to de-assert the CTS line. If, after Host Serial Response Time-out, the CTS line is still asserted, the scanner sounds a transmit error, and any scanned data is lost.
- When the CTS line is de-asserted, the scanner asserts the RTS line and waits up to Host Serial Response Time-out for the host to assert CTS. When the host asserts CTS, data is transmitted. If, after Host Serial Response Time-out, the CTS line is not asserted, the scanner sounds a transmit error, and discards the data.
- When data transmission is complete, the scanner de-asserts RTS 10 msec after sending the last character.
- The host should respond by negating CTS. The scanner checks for a de-asserted CTS upon the next transmission of data.

During the transmission of data, the CTS line should be asserted. If CTS is de-asserted for more than 50 ms between characters, the transmission is aborted, the scanner sounds a transmission error, and the data is discarded.

If the above communication sequence fails, the scanner issues an error indication. In this case, the data is lost and must be rescanned.

If Hardware Handshaking and Software Handshaking are both enabled, Hardware Handshaking takes precedence.



### NOTE

**The DTR signal is jumpered to the active state.**

- None: Scan the bar code below if no Hardware Handshaking is desired.
- Standard RTS/CTS: Scan the bar code below to select Standard RTS/CTS Hardware Handshaking.
- RTS/CTS Option 1: When RTS/CTS Option 1 is selected, the scanner asserts RTS before transmitting and ignores the state of CTS. The scanner de-asserts RTS when the transmission is complete.
- RTS/CTS Option 2: When Option 2 is selected, RTS is always high or low (user-programmed logic level). However, the scanner waits for CTS to be asserted before transmitting data. If CTS is not asserted within Host Serial Response Time-out, the scanner issues an error indication and discards the data.

## Hardware Handshaking – cont.

- **RTS/CTS Option 3:** When Option 3 is selected, the scanner asserts RTS prior to any data transmission, regardless of the state of CTS. The scanner waits up to Host Serial Response Time-out for CTS to be asserted. If CTS is not asserted during this time, the scanner issues an error indication and discards the data. The scanner de-asserts RTS when transmission is complete.



**\*None**

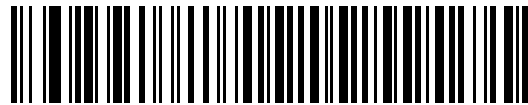

**Standard RTS/CTS**

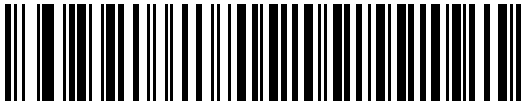

**RTS/CTS Option 1**



**RTS/CTS Option 2**

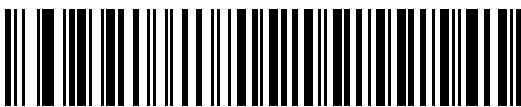

**RTS/CTS Option 3**



## Software Handshaking

This parameter offers control of the data transmission process in addition to, or instead of, that offered by hardware handshaking. There are five options.

If Software Handshaking and Hardware Handshaking are both enabled, Hardware Handshaking takes precedence.

- **None:** When this option is selected, data is transmitted immediately. No response is expected from host.
- **ACK/NAK:** When this option is selected, after transmitting data, the scanner expects either an ACK or NAK response from the host. When a NAK is received, the scanner transmits the same data again and waits for either an ACK or NAK. After three unsuccessful attempts to send data when NAKs are received, the scanner issues an error indication and discards the data.

The scanner waits up to the programmable Host Serial Response Time-out to receive an ACK or NAK. If the scanner does not get a response in this time, it issues an error indication and discards the data. There are no retries when a time-out occurs.

- **ENQ:** When this option is selected, the scanner waits for an ENQ character from the host before transmitting data. If an ENQ is not received within the Host Serial Response Time-out, the scanner issues an error indication and discards the data. The host must transmit an ENQ character at least every Host Serial Response Time-out to prevent transmission errors.
- **ACK/NAK with ENQ:** This combines the two previous options. For re-transmissions of data, due to a NAK from the host, an additional ENQ is not required.
- **XON/XOFF:** An XOFF character turns the scanner transmission off until the scanner receives an XON character. There are two situations for XON/XOFF:
  - XOFF is received before the scanner has data to send. When the scanner has data to send, it waits up to Host Serial Response Time-out for an XON character before transmission. If the XON is not received within this time, the scanner issues an error indication and discards the data.
  - XOFF is received during a transmission. Data transmission then stops after sending the current byte. When the scanner receives an XON character, it sends the rest of the data message. The scanner waits up to 30 seconds for the XON.

## Software Handshaking – cont.



\*None



ACK/NAK

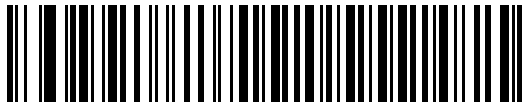

ENQ



ACK/NAK with ENQ

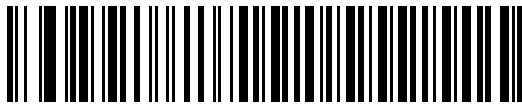

XON/XOFF

## Host Serial Response Time-out

This parameter specifies how long the scanner waits for an ACK, NAK, ENQ, XON, or CTS before determining that a transmission error occurred.



**\*Minimum: 2 Sec**



**Low: 2.5 Sec**

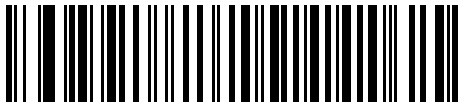

**Medium: 5 Sec**



**High: 7.5 Sec**

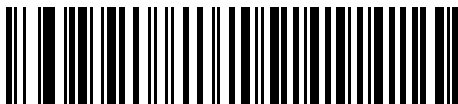

**Maximum: 9.9 Sec**

## RTS Line State

This parameter sets the idle state of the Serial Host RTS line. Scan a bar code below to select Low RTS or High RTS line state.

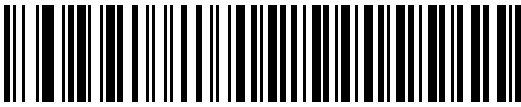

**\*Host: Low RTS**



**Host: High RTS**

## Beep on <BEL>

When this parameter is enabled, the scanner issues a beep when a <BEL> character is detected on the RS-232 serial line. <BEL> is issued to gain a user's attention to an illegal entry or other important event.

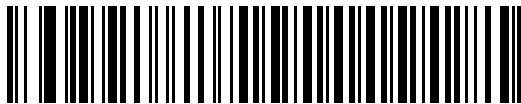

**Beep On <BEL> Character  
(Enable)**



**\*Do Not Beep On <BEL> Character  
(Disable)**

## Intercharacter Delay

This parameter specifies the intercharacter delay inserted between character transmissions.



**\*Minimum: 0 msec**



**Low: 25 msec**

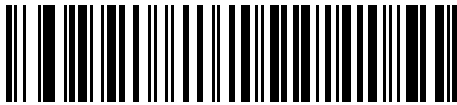

**Medium: 50 msec**



**High: 75 msec**

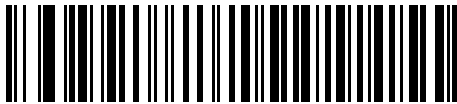

**Maximum: 99 msec**

## Nixdorf Beep/LED Options

When Nixdorf Mode B is selected, this indicates when the scanner should beep and turn on its LED after a decode.

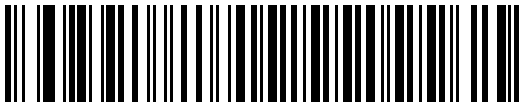

**\*Normal Operation**  
(Beep/LED immediately after decode)

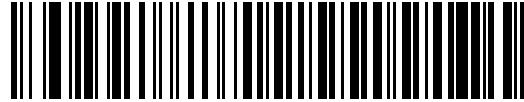

**Beep/LED After Transmission**

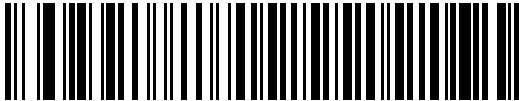

**Beep/LED After CTS Pulse**

## Ignore Unknown Characters

Unknown characters are characters the host does not recognize. When Send Bar Codes with Unknown Characters is selected, all bar code data is sent except for unknown characters, and no error beeps sound on the scanner. When Do Not Send Bar Codes With Unknown Characters is selected, bar code data is sent up to the first unknown character and then an error beep sounds on the scanner.

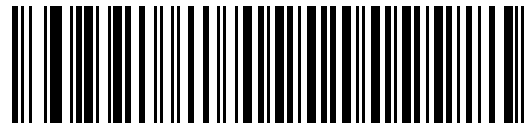

**\*Send Bar Code with Unknown Characters**

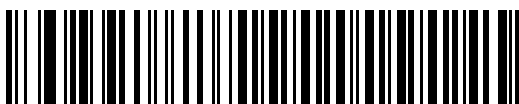

**Do Not Send Bar Codes with Unknown Characters**

## ASCII Character Set for RS-232

The values in [Table 8](#) can be assigned as prefixes or suffixes for ASCII character data transmission.

**Table 8. ASCII Character Set for RS-232**

ASCII Value	Full ASCII Code 39 Encode Character	ASCII Character
1000	%U	NUL
1001	\$A	SOH
1002	\$B	STX
1003	\$C	ETX
1004	\$D	EOT
1005	\$E	ENQ
1006	\$F	ACK
1007	\$G	BELL
1008	\$H	BCKSPC
1009	\$I	HORIZ TAB
1010	\$J	LF/NW LN
1011	\$K	VT
1012	\$L	FF
1013	\$M	CR/ENTER
1014	\$N	SO
1015	\$O	SI
1016	\$P	DLE
1017	\$Q	DC1/XON
1018	\$R	DC2
1019	\$S	DC3/XOFF
1020	\$T	DC4
1021	\$U	NAK
1022	\$V	SYN
1023	\$W	ETB
1024	\$X	CAN
1025	\$Y	EM
1026	\$Z	SUB

**Table 8. ASCII Character Set for RS-232 (Continued)**

ASCII Value	Full ASCII Code 39 Encode Character	ASCII Character
1027	%A	ESC
1028	%B	FS
1029	%C	GS
1030	%D	RS
1031	%E	US
1032	Space	Space
1033	/A	!
1034	/B	"
1035	/C	#
1036	/D	\$
1037	/E	%
1038	/F	&
1039	/G	'
1040	/H	(
1041	/I	)
1042	/J	*
1043	/K	+
1044	/L	,
1045	-	-
1046	.	.
1047	/O	/
1048	0	0
1049	1	1
1050	2	2
1051	3	3
1052	4	4
1053	5	5
1054	6	6
1057	7	7
1056	8	8



**Table 8. ASCII Character Set for RS-232 (Continued)**

ASCII Value	Full ASCII Code 39 Encode Character	ASCII Character
1057	9	9
1058	/Z	:
1059	%F	;
1060	%G	<
1061	%H	=
1062	%I	>
1063	%J	?
1064	%V	@
1065	A	A
1066	B	B
1067	C	C
1068	D	D
1069	E	E
1070	F	F
1071	G	G
1072	H	H
1073	I	I
1074	J	J
1075	K	K
1076	L	L
1077	M	M
1078	N	N
1079	O	O
1080	P	P
1081	Q	Q
1082	R	R
1083	S	S
1084	T	T
1085	U	U
1086	V	V

**Table 8. ASCII Character Set for RS-232 (Continued)**

ASCII Value	Full ASCII Code 39 Encode Character	ASCII Character
1087	W	W
1088	X	X
1089	Y	Y
1090	Z	Z
1091	%K	[
1092	%L	\
1093	%M	]
1094	%N	^
1095	%O	_
1096	%W	`
1097	+A	a
1098	+B	b
1099	+C	c
1100	+D	d
1101	+E	e
1102	+F	f
1103	+G	g
1104	+H	h
1105	+I	i
1106	+J	j
1107	+K	k
1108	+L	l
1109	+M	m
1110	+N	n
1111	+O	o
1112	+P	p
1113	+Q	q
1114	+R	r
1115	+S	s
1116	+T	t

**Table 8. ASCII Character Set for RS-232 (Continued)**

ASCII Value	Full ASCII Code 39 Encode Character	ASCII Character
1117	+U	u
1118	+V	v
1119	+W	w
1120	+X	x
1121	+Y	y
1122	+Z	z
1123	%P	{
1124	%Q	
1125	%R	}
1126	%S	~
1127		Undefined
7013		ENTER

# NOTES

# Chapter 7

## Keyboard Wedge Interface

This chapter describes how to set up a Keyboard Wedge interface with the scanner. With this interface, the scanner is connected between the keyboard and host computer, and translates bar code data into keystrokes. The host computer accepts the keystrokes as if they originated from the keyboard. This mode adds bar code reading functionality to a system designed for manual keyboard input. Keyboard keystrokes are simply passed through.

Throughout the programming bar code menus, default values are indicated with asterisks (\*).



\* Indicates Default      \*North American      Feature/Option

### Connecting a Keyboard Wedge Interface

Figure 9. Keyboard Wedge Connection with Y-cable

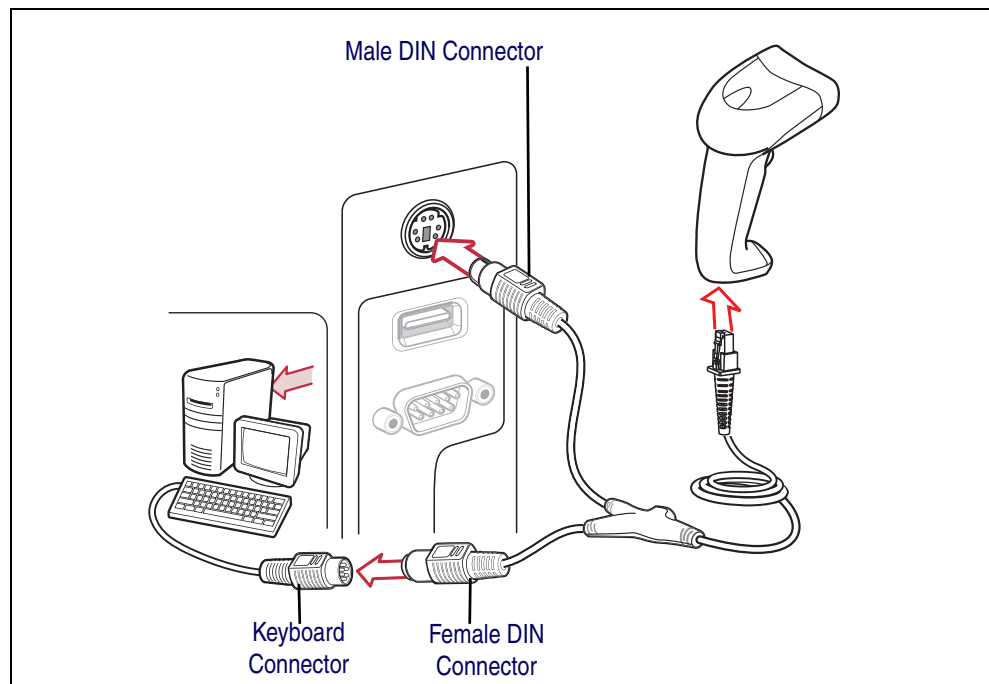

To connect the Keyboard Wedge interface Y-cable:



**Interface cables vary depending on configuration. The connectors illustrated in Figure 1 are examples only. The connectors may be different than those illustrated, but the steps to connect the scanner remain the same.**

**NOTE**

1. Turn off the host and unplug the keyboard connector.
2. Attach the modular connector of the Y-cable to the cable interface port on the scanner. (See [Installing the Interface Cable on page 6.](#))
3. Connect the round male DIN host connector of the Y-cable to the keyboard port on the host device.
4. Connect the round female DIN keyboard connector of the Y-cable to the keyboard connector.
5. If needed, attach the optional power supply to the connector in the middle of the Y-cable.
6. Ensure that all connections are secure.
7. Turn on the host system.
8. Select the Keyboard Wedge host type by scanning the appropriate bar code from [Keyboard Wedge Host Parameters on page 57.](#)
9. To modify any other parameter options, scan the appropriate bar codes in this chapter.

## Keyboard Wedge Parameter Defaults



See [Appendix B, Standard Defaults](#) for all user preferences, hosts, symbolologies, and miscellaneous default parameters.

**NOTE**

[Table 9](#) lists the defaults for Keyboard Wedge host parameters. To change any option, scan the appropriate bar code(s) in the Keyboard Wedge Host Parameters section beginning on [page 57.](#)

**Table 9. Keyboard Wedge Defaults**

Parameter	Default	Page Number
<b>Keyboard Wedge Host Parameters</b>		
Keyboard Wedge Host Type	IBM PC/AT& IBM PC Compatibles <sup>1</sup>	<a href="#">57</a>
Country Types (Country Codes)	North American	<a href="#">58</a>
Ignore Unknown Characters	Send	<a href="#">59</a>
Keystroke Delay	No Delay	<a href="#">60</a>
Intra-Keystroke Delay	Disable	<a href="#">60</a>

**Table 9. Keyboard Wedge Defaults (Continued)**

Parameter	Default	Page Number
Alternate Numeric Keypad Emulation	Disable	61
Caps Lock On	Disable	61
Caps Lock Override	Disable	62
Convert Wedge Data	No Convert	62
Function Key Mapping	Disable	63
FN1 Substitution	Disable	63
Send and Make Break	Send	63

<sup>1</sup>User selection is required to configure this interface and this is the most common selection.

## Keyboard Wedge Host Parameters

### Keyboard Wedge Host Types

Select the Keyboard Wedge host by scanning one of the bar codes below.



User selection is required to configure this interface and this is the most common selection.

#### NOTE

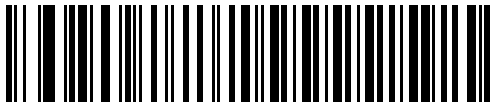

IBM PC/AT & IBM PC Compatibles<sup>1</sup>

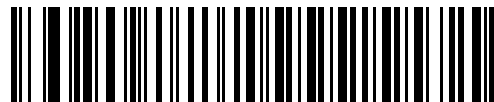

IBM AT Notebook

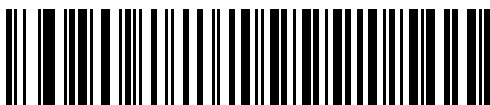

NCR 7052



IBM PS/2 (Model 30)

## Keyboard Wedge Country Types (Country Codes)

Scan the bar code corresponding to the keyboard type. If the keyboard type is not listed, see [Alternate Numeric Keypad Emulation on page 61](#).

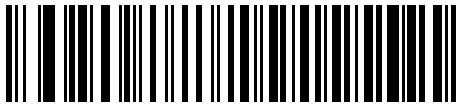

**\*North American**



**German Windows**

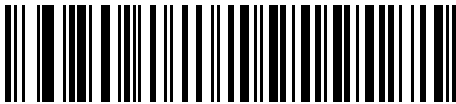

**French Windows**

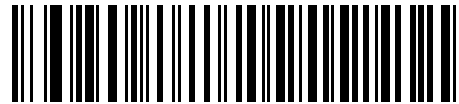

**French Canadian Windows 95/98**

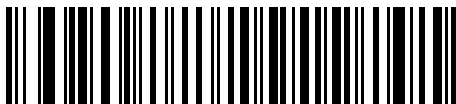

**French Canadian Windows XP/2000**

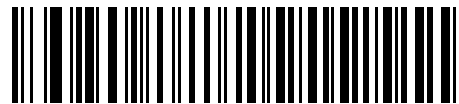

**Spanish Windows**

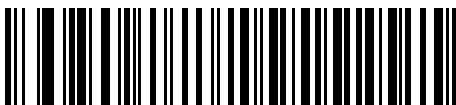

**Italian Windows**



## Keyboard Wedge Country Types (continued)



Swedish Windows



UK English Windows

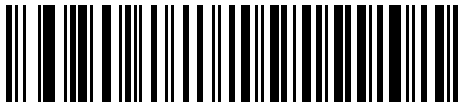

Japanese Windows



Portuguese-Brazilian Windows

## Ignore Unknown Characters

Unknown characters are characters the host does not recognize. When Send Bar Codes With Unknown Characters is selected, all bar code data is sent except for unknown characters, and no error beeps sound on the scanner. When Do Not Send Bar Codes With Unknown Characters is selected, bar code data is sent up to the first unknown character, then the scanner issues an error beep.



\*Send Bar Codes with Unknown Characters



Do Not Send Bar Codes with Unknown Characters

## Keystroke Delay

This is the delay in milliseconds between emulated keystrokes. Scan a bar code below to increase the delay when hosts require a slower transmission of data.

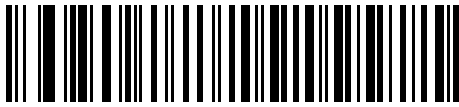

**\*No Delay**



**Medium Delay (20 msec)**

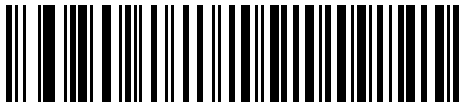

**Long Delay (40 msec)**

## Intra-Keystroke Delay

When enabled, an additional delay is inserted between each emulated key depression and release. This sets the Keystroke Delay parameter to a minimum of 5 msec as well.

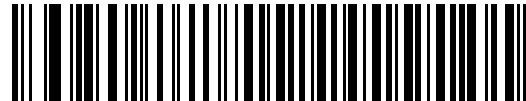

**Enable Intra-Keystroke Delay**



**\*Disable Intra-Keystroke Delay**

## Alternate Numeric Keypad Emulation

This allows emulation of most other country keyboard types not listed in [Keyboard Wedge Country Types \(Country Codes\)](#) on page 58 in a Microsoft® operating system environment.

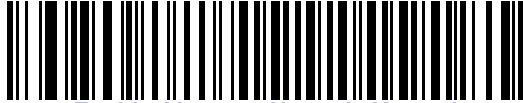

Enable Alternate Numeric Keypad

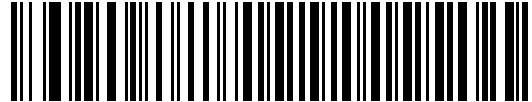

~Disable Alternate Numeric Keypad

## Caps Lock On

When enabled, the scanner emulates keystrokes as if the Caps Lock key is always pressed. Note that if both Caps Lock On and Caps Lock Override are enabled, Caps Lock Override takes precedence



Enable Caps Lock On



\*Disable Caps Lock On

## Caps Lock Override

When enabled, on AT or AT Notebook hosts, the keyboard ignores the state of the Caps Lock key. Therefore, an 'A' in the bar code is sent as an 'A' no matter what the state of the keyboard's Caps Lock key.



If both Caps Lock On and Caps Lock Override are enabled, Caps Lock Override takes precedence.

### NOTE

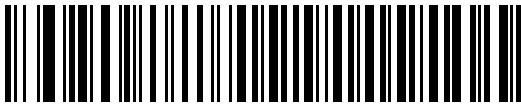

Enable Caps Lock Override

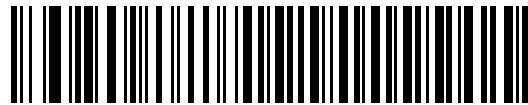

\*Disable Caps Lock Override

## Convert Wedge Data

When enabled, the scanner will convert all bar code data to the selected case.

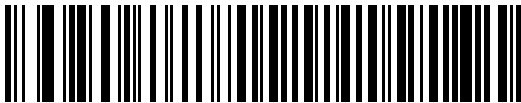

Convert to Upper Case



Convert to Lower Case

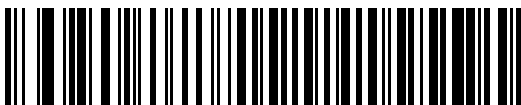

^No Convert

## Function Key Mapping

ASCII values under 32 are normally sent as control key sequences (see [Table 10 on page 64](#)). When this parameter is enabled, the keys in bold are sent in place of the standard key mapping. Table entries that do not have a bold entry remain the same whether or not this parameter is enabled.

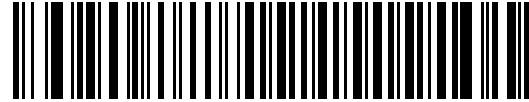

**Enable Function Key Mapping**

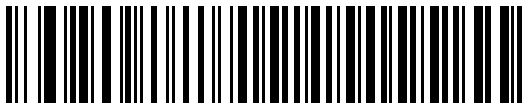

**\*Disable Function Key Mapping**

## FN1 Substitution

When enabled, the scanner replaces FN1 characters in an EAN128 bar code with a key-stroke chosen by the user (see [FN1 Substitution Values on page 30](#)).

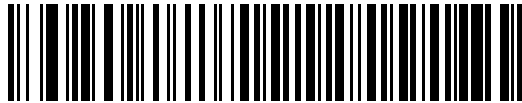

**Enable FN1 Substitution**

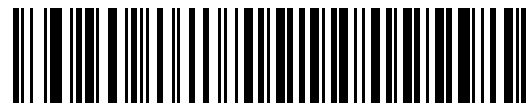

**\*Disable FN1 Substitution**

## Send Make and Break

When enabled, the scan codes for releasing a key are not sent.

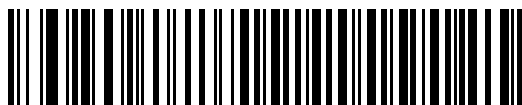

**\*Send Make and Break Scan Codes**



**Send Make Scan Code Only**

## Keyboard Maps

The following keyboard maps are provided for prefix/suffix keystroke parameters. To program the prefix/suffix values, see the bar codes on [page 27](#) through [page 29](#).

**Figure 10. IBM PC/AT**

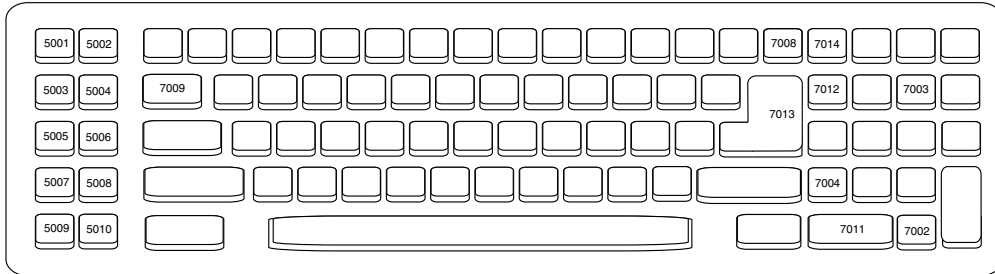

**Figure 11. IBM PS/2**

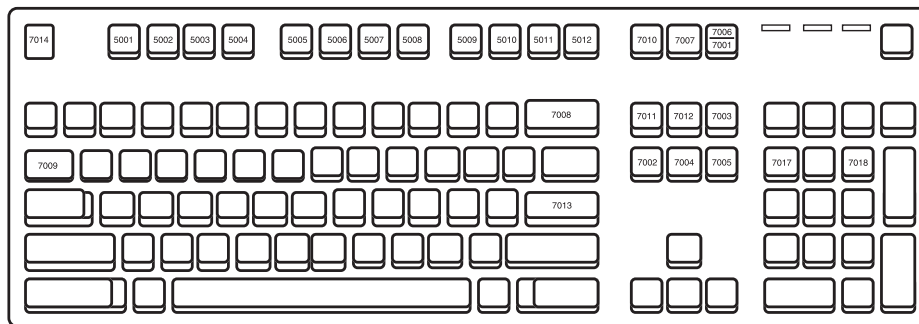

## ASCII Character Set for Keyboard Wedge



**NOTE**

Code 39 Full ASCII interprets the bar code special character (\$ + % /) preceding a Code 39 character and assigns an ASCII character value to the pair. For example, when Code 39 Full ASCII is enabled and a +B is scanned, it is interpreted as b, %J as ?, and %V as @. Scanning ABC%I outputs the keystroke equivalent of ABC >.

**Table 10. Keyboard Wedge ASCII Character Set**

ASCII Value	Full ASCII Code 39 Encode Character	Keystroke
1001	\$A	CTRL A
1002	\$B	CTRL B
1003	\$C	CTRL C
1004	\$D	CTRL D

<sup>1</sup>The keystroke in bold is sent only if the “Function Key Mapping” is enabled. Otherwise, the unbolded keystroke is sent.

**Table 10. Keyboard Wedge ASCII Character Set (Continued)**

ASCII Value	Full ASCII Code 39 Encode Character	Keystroke
1005	\$E	CTRL E
1006	\$F	CTRL F
1007	\$G	CTRL G
1008	\$H	CTRL H/ <b>BACKSPACE</b> <sup>1</sup>
1009	\$I	CTRL I/ <b>HORIZONTAL TAB</b> <sup>1</sup>
1010	\$J	CTRL J
1011	\$K	CTRL K
1012	\$L	CTRL L
1013	\$M	CTRL M/ <b>ENTER</b> <sup>1</sup>
1014	\$N	CTRL N
1015	\$O	CTRL O
1016	\$P	CTRL P
1017	\$Q	CTRL Q
1018	\$R	CTRL R
1019	\$S	CTRL S
1020	\$T	CTRL T
1021	\$U	CTRL U
1022	\$V	CTRL V
1023	\$W	CTRL W
1024	\$X	CTRL X
1025	\$Y	CTRL Y
1026	\$Z	CTRL Z
1027	%A	CTRL [ <b>/ESC</b> <sup>1</sup>
1028	%B	CTRL \
1029	%C	CTRL ]
1030	%D	CTRL 6
1031	%E	CTRL -
1032	Space	Space

<sup>1</sup>The keystroke in bold is sent only if the "Function Key Mapping" is enabled. Otherwise, the unbolded keystroke is sent.

**Table 10. Keyboard Wedge ASCII Character Set (Continued)**

ASCII Value	Full ASCII Code 39 Encode Character	Keystroke
1033	/A	!
1034	/B	“
1035	/C	#
1036	/D	\$
1037	/E	%
1038	/F	&
1039	/G	‘
1040	/H	(
1041	/I	)
1042	/J	*
1043	/K	+
1044	/L	,
1045	-	-
1046	.	.
1047	/O	/
1048	0	0
1049	1	1
1050	2	2
1051	3	3
1052	4	4
1053	5	5
1054	6	6
1055	7	7
1056	8	8
1057	9	9
1058	/Z	:
1059	%F	;
1060	%G	<

<sup>1</sup>The keystroke in bold is sent only if the “Function Key Mapping” is enabled. Otherwise, the unbolded keystroke is sent.



**Table 10. Keyboard Wedge ASCII Character Set (Continued)**

ASCII Value	Full ASCII Code 39 Encode Character	Keystroke
1061	%H	=
1062	%I	>
1063	%J	?
1064	%V	@
1065	A	<b>A</b>
1066	B	<b>B</b>
1067	C	<b>C</b>
1068	D	<b>D</b>
1069	E	<b>E</b>
1070	F	<b>F</b>
1071	G	<b>G</b>
1072	H	<b>H</b>
1073	I	<b>I</b>
1074	J	<b>J</b>
1075	K	<b>K</b>
1076	L	<b>L</b>
1077	M	<b>M</b>
1078	N	<b>N</b>
1079	O	<b>O</b>
1080	P	<b>P</b>
1081	Q	<b>Q</b>
1082	R	<b>R</b>
1083	S	<b>S</b>
1084	T	<b>T</b>
1085	U	<b>U</b>
1086	V	<b>V</b>
1087	W	<b>W</b>
1088	X	<b>X</b>

<sup>1</sup>The keystroke in bold is sent only if the "Function Key Mapping" is enabled. Otherwise, the unbolded keystroke is sent.

**Table 10. Keyboard Wedge ASCII Character Set (Continued)**

ASCII Value	Full ASCII Code 39 Encode Character	Keystroke
1089	Y	Y
1090	Z	Z
1091	%K	[
1092	%L	\
1093	%M	]
1094	%N	^
1095	%O	_
1096	%W	'
1097	+A	<b>a</b>
1098	+B	<b>b</b>
1099	+C	<b>c</b>
1100	+D	<b>d</b>
1101	+E	<b>e</b>
1102	+F	<b>f</b>
1103	+G	<b>g</b>
1104	+H	<b>h</b>
1105	+I	<b>i</b>
1106	+J	<b>j</b>
1107	+K	<b>k</b>
1108	+L	<b>l</b>
1109	+M	<b>m</b>
1110	+N	<b>n</b>
1111	+O	<b>o</b>
1112	+P	<b>p</b>
1113	+Q	<b>q</b>
1114	+R	<b>r</b>
1115	+S	<b>s</b>
1116	+T	<b>t</b>

<sup>1</sup>The keystroke in bold is sent only if the "Function Key Mapping" is enabled. Otherwise, the unbolded keystroke is sent.

**Table 10. Keyboard Wedge ASCII Character Set (Continued)**

ASCII Value	Full ASCII Code 39 Encode Character	Keystroke
1117	+U	u
1118	+V	v
1119	+W	w
1120	+X	x
1121	+Y	y
1122	+Z	z
1123	%P	{
1124	%Q	
1125	%R	}
1126	%S	~

<sup>1</sup>The keystroke in bold is sent only if the “Function Key Mapping” is enabled. Otherwise, the unbolded keystroke is sent.

**Table 11. Keyboard Wedge ALT Key Character Set**

ALT Keys	Keystroke
2065	ALT A
2066	ALT B
2067	ALT C
2068	ALT D
2069	ALT E
2070	ALT F
2071	ALT G
2072	ALT H
2073	ALT I
2074	ALT J
2075	ALT K
2076	ALT L
2077	ALT M
2078	ALT N
2079	ALT O
2080	ALT P

**Table 11. Keyboard Wedge ALT Key Character Set (Continued)**

ALT Keys	Keystroke
2081	ALT Q
2082	ALT R
2083	ALT S
2084	ALT T
2085	ALT U
2086	ALT V
2087	ALT W
2088	ALT X
2089	ALT Y
2090	ALT Z

**Table 12. Keyboard Wedge GIU Key Character Set**

GUI Keys	Keystrokes
3000	Right Control Key
3048	GUI 0
3049	GUI 1
3050	GUI 2
3051	GUI 3
3052	GUI 4
3053	GUI 5
3054	GUI 6
3055	GUI 7
3056	GUI 8
3057	GUI 9
3065	GUI A
3066	GUI B
3067	GUI C
3068	GUI D
3069	GUI E
3070	GUI F
3071	GUI G
3072	GUI H

**Table 12. Keyboard Wedge GUI Key Character Set (Continued)**

GUI Keys	Keystrokes
3073	GUI I
3074	GUI J
3075	GUI K
3076	GUI L
3077	GUI M
3078	GUI N
3079	GUI O
3080	GUI P
3081	GUI Q
3082	GUI R
3083	GUI S
3084	GUI T
3085	GUI U
3086	GUI V
3087	GUI W
3088	GUI X
3089	GUI Y
3090	GUI Z

**Table 13. Keyboard Wedge F Key Character Set**

F Keys	Keystroke
5001	F1
5002	F2
5003	F3
5004	F4
5005	F5
5006	F6
5007	F7
5008	F8
5009	F9

**Table 13. Keyboard Wedge F Key Character Set (Continued)**

F Keys	Keystroke
5010	F10
5011	F11
5012	F12
5013	F13
5014	F14
5015	F15
5016	F16
5017	F17
5018	F18
5019	F19
5020	F20
5021	F21
5022	F22
5023	F23
5024	F24

**Table 14. Keyboard Wedge Numeric Keypad Character Set**

Numeric Keypad	Keystroke
6042	*
6043	+
6044	undefined
6045	-
6046	.
6047	/
6048	0
6049	1
6050	2
6051	3
6052	4
6053	5

**Table 14. Keyboard Wedge Numeric Keypad Character Set (Continued)**

Numeric Keypad	Keystroke
6054	6
6055	7
6056	8
6057	9
6058	Enter
6059	Num Lock

**Table 15. Keyboard Wedge Extended Keypad Character Set**

Extended Keypad	Keystroke
7001	Break
7002	Delete
7003	Pg Up
7004	End
7005	Pg Dn
7006	Pause
7007	Scroll Lock
7008	Backspace
7009	Tab
7010	Print Screen
7011	Insert
7012	Home
7013	Enter
7014	Escape
7015	Up Arrow
7016	Dn Arrow
7017	Left Arrow
7018	Right Arrow

# NOTES



# Chapter 8

## USB Interface

This chapter covers the connection and setup of the scanner to a USB host. The scanner attaches directly to a USB host, or a powered USB hub, and is powered by it. No additional power supply is required.

Throughout the programming bar code menus, default values are indicated with asterisks (\*).



\* Indicates Default — \*North American Standard USB Keyboard — Feature/Option

### Connecting a USB Interface

Figure 12. USB Connection

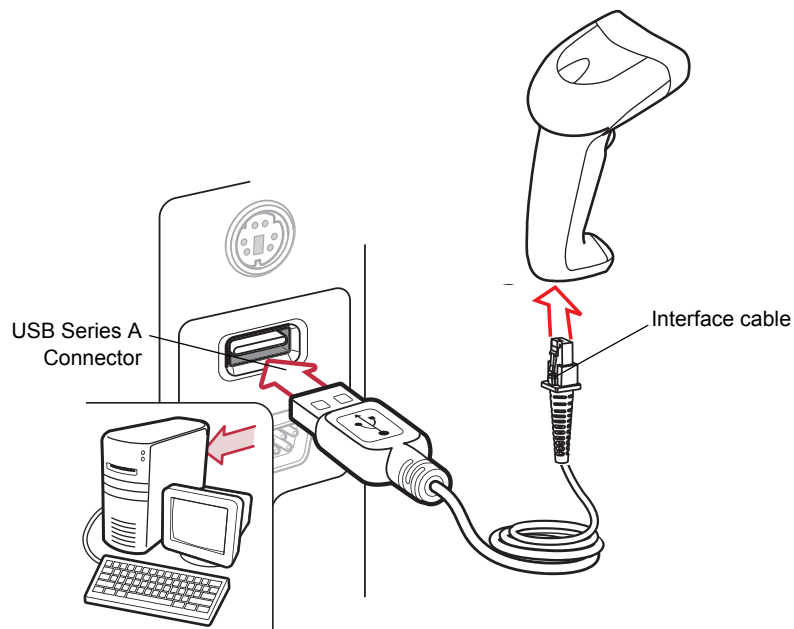

The scanner connects with USB capable hosts including:

- Desktop PCs and Notebooks
- Apple™ iMac, G4, iBooks (North America only)
- IBM SurePOS terminals

- Sun, IBM, and other network computers that support more than one keyboard.

The following operating systems support the scanner through USB:

- Windows 98, 2000, ME, XP
- MacOS 8.5 and above
- IBM 4690 OS.

The scanner will also interface with other USB hosts which support USB Human Interface Devices (HID). For more information on USB technology, hosts, and peripheral devices, visit the website listed on the back cover of this manual.



**Interface cables vary depending on configuration. The connectors illustrated in Figure 12 are examples only. The connectors may be different than those illustrated, but the steps to connect the scanner remain the same.**

#### NOTE

To set up the scanner:

1. Attach the modular connector of the USB interface cable to the cable interface port on the scanner (see [Installing the Interface Cable on page 6](#)).
2. Plug the series A connector in the USB host or hub, or plug the Plus Power connector in an available port of the IBM SurePOS terminal.
3. Select the USB device type by scanning the appropriate bar code from [USB Device Type on page 77](#).
4. On first installation when using Windows, the software prompts to select or install the Human Interface Device driver. To install this driver, provided by Windows, click *Next* through all the choices and click *Finished* on the last choice. The scanner powers up during this installation.
5. To modify any other parameter options, scan the appropriate bar codes in this chapter.
6. If problems occur with the system, see [Table 3](#).

## USB Parameter Defaults

[Table 16](#) lists the defaults for USB host parameters. If any option needs to be changed, scan the appropriate bar code(s) provided in the Parameter Descriptions section beginning on [page 77](#).



**See [Appendix B, Standard Defaults](#) for all user preferences, hosts, symbolologies, and miscellaneous default parameters.**

#### NOTE

**Table 16. USB Defaults**

Parameter	Default	Page Number
<b>USB Host Parameters</b>		
USB Device Type	HID Keyboard Emulation	77
USB Country Keyboard Types (Country Codes)	North American	78
USB Keystroke Delay	No Delay	80
USB CAPS Lock Override	Disable	80
USB Ignore Unknown Characters	Send	81
Emulate Keypad	Disable	81
USB FN1 Substitution	Disable	82
Function Key Mapping	Disable	82
Simulated Caps Lock	Disable	83
Convert Case	No Case Conversion	83

## USB Host Parameters

### USB Device Type

Select the desired USB device type.



When changing USB Device Types, the scanner automatically restarts. The scanner issues the standard startup beep sequences.

#### NOTE

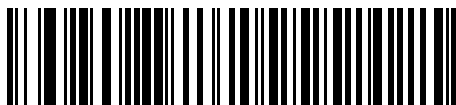

\*USB Keyboard



USB OEM Table Top

## USB Device Type – continued



USB OEM Handheld



For USB OPOS operation, use host type OEM USB and an appropriate driver supplied by Datalogic.

NOTE

## USB Country Keyboard Types (Country Codes)

Scan the bar code corresponding to the keyboard type. This setting applies only to the USB HID Keyboard Emulation device.



When changing USB country keyboard types the scanner automatically resets. The scanner issues the standard startup beep sequences.

NOTE

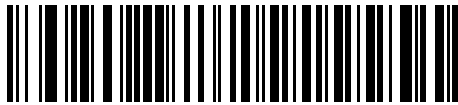

\*North American Standard USB Keyboard



German Windows

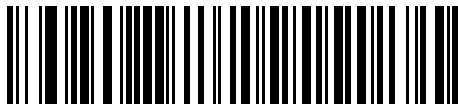

French Windows



French Canadian Windows 95/98

## USB Country Keyboard Types (Country Codes continued)



French Canadian Windows 2000/XP



Spanish Windows

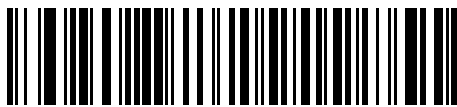

Italian Windows



Swedish Windows

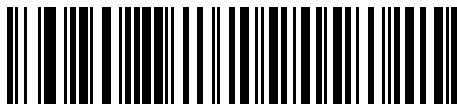

UK English Windows



Japanese Windows (ASCII)

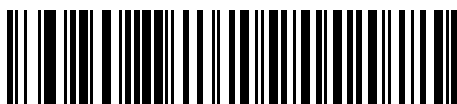

Portuguese-Brazilian Windows

## USB Keystroke Delay

This parameter sets the delay, in milliseconds, between emulated keystrokes. Scan a bar code below to increase the delay when hosts require a slower transmission of data.



**\*No Delay**



**Medium Delay (20 msec)**

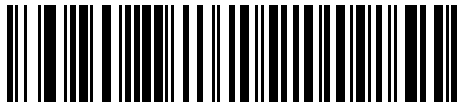

**Long Delay (40 msec)**

## USB CAPS Lock Override

This option applies only to the HID Keyboard Emulation device. When enabled, the case of the data is preserved regardless of the state of the caps lock key. This setting is always enabled for the “Japanese, Windows (ASCII)” keyboard type and cannot be disabled.

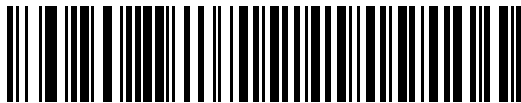

**Override Caps Lock Key  
(Enable)**



**\*Do Not Override Caps Lock Key  
(Disable)**

## USB Ignore Unknown Characters

This option applies only to the HID Keyboard Emulation device and IBM device. Unknown characters are characters the host does not recognize. When Send Bar Codes With Unknown Characters is selected, all bar code data is sent except for unknown characters, and no error beeps sound. When Do Not Send Bar Codes With Unknown Characters is selected, bar code data is sent up to the first unknown character, then the scanner issues an error beep.

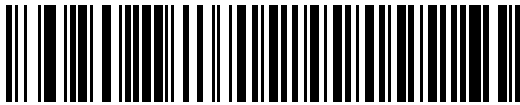

**\*Send Bar Codes with Unknown Characters**

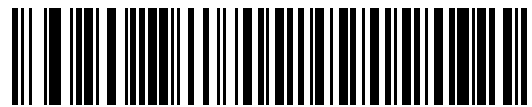

**Do Not Send Bar Codes with Unknown Characters**

## Emulate Keypad

When enabled, all characters are sent as ASCII sequences over the numeric keypad. For example ASCII A would be sent as “ALT make” 0 6 5 “ALT Break.”



**\*Disable Keypad Emulation**

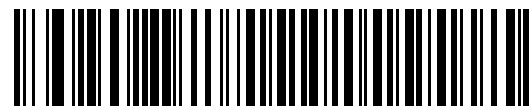

**Enable Keypad Emulation**

## USB Keyboard FN 1 Substitution

This option applies only to the USB HID Keyboard Emulation device. When enabled, this allows replacement of any FN 1 characters in an EAN 128 bar code with a Key Category and value chosen by the user (see [FN1 Substitution Values on page 30](#) to set the Key Category and Key Value).

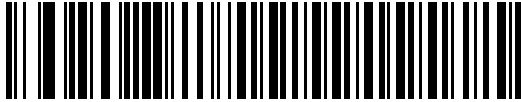

**Enable FN1 Substitution**

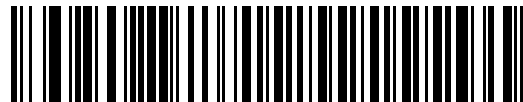

**\*Disable FN1 Substitution**

## Function Key Mapping

ASCII values under 32 are normally sent as a control-key sequences (see [Table 17 on page 84](#)). When this parameter is enabled, the keys in bold are sent in place of the standard key mapping. Table entries that do not have a bold entry remain the same whether or not this parameter is enabled.

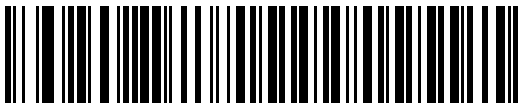

**\*Disable Function Key Mapping**



**Enable Function Key Mapping**



## Simulated Caps Lock

When enabled, the scanner will invert upper and lower case characters on the scanner bar code as if the Caps Lock state is enabled on the keyboard. This inversion is done regardless of the current state of the keyboard's Caps Lock state.

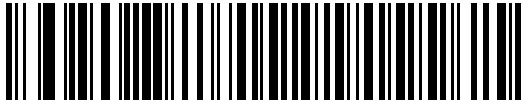

**\*Disable Simulated Caps Lock**

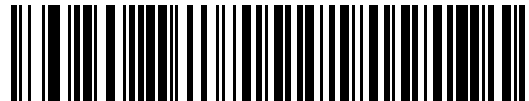

**Enable Simulated Caps Lock**

## Convert Case

When enabled, the scanner will convert all bar code data to the selected case.

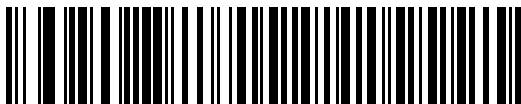

**\*No Case Conversion**

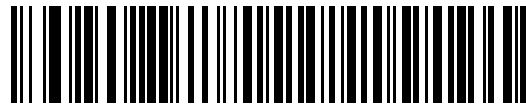

**Convert All to Upper Case**

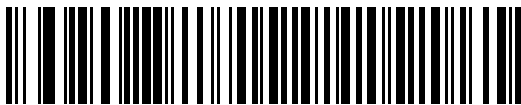

**Convert All to Lower Case**

## ASCII Character Set for USB

**Table 17. ASCII Character Set for USB**

ASCII Value	Full ASCII Code 39 Encode Character	Keystroke
1000	%U	CTRL 2
1001	\$A	CTRL A
1002	\$B	CTRL B
1003	\$C	CTRL C
1004	\$D	CTRL D
1005	\$E	CTRL E
1006	\$F	CTRL F
1007	\$G	CTRL G
1008	\$H	CTRL H/ <b>BACKSPACE</b> <sup>1</sup>
1009	\$I	CTRL I/ <b>HORIZONTAL TAB</b> <sup>1</sup>
1010	\$J	CTRL J
1011	\$K	CTRL K
1012	\$L	CTRL L
1013	\$M	CTRL M/ <b>ENTER</b> <sup>1</sup>
1014	\$N	CTRL N
1015	\$O	CTRL O
1016	\$P	CTRL P
1017	\$Q	CTRL Q
1018	\$R	CTRL R
1019	\$S	CTRL S
1020	\$T	CTRL T
1021	\$U	CTRL U
1022	\$V	CTRL V
1023	\$W	CTRL W
1024	\$X	CTRL X
1025	\$Y	CTRL Y

<sup>1</sup>The keystroke in bold is sent only if the "Function Key Mapping" is enabled. Otherwise, the unbolded keystroke is sent.

**Table 17. ASCII Character Set for USB (Continued)**

ASCII Value	Full ASCII Code 39 Encode Character	Keystroke
1026	\$Z	CTRL Z
1027	%A	CTRL [ <b>/ESC</b> <sup>1</sup>
1028	%B	CTRL \
1029	%C	CTRL ]
1030	%D	CTRL 6
1031	%E	CTRL -
1032	Space	Space
1033	/A	!
1034	/B	“
1035	/C	#
1036	/D	\$
1037	/E	%
1038	/F	&
1039	/G	‘
1040	/H	(
1041	/I	)
1042	/J	*
1043	/K	+
1044	/L	,
1045	-	-
1046	.	.
1047	/O	/
1048	0	0
1049	1	1
1050	2	2
1051	3	3
1052	4	4
1053	5	5

<sup>1</sup>The keystroke in bold is sent only if the “Function Key Mapping” is enabled. Otherwise, the unbolded keystroke is sent.

**Table 17. ASCII Character Set for USB (Continued)**

ASCII Value	Full ASCII Code 39 Encode Character	Keystroke
1054	6	6
1055	7	7
1056	8	8
1057	9	9
1058	/Z	:
1059	%F	;
1060	%G	<
1061	%H	=
1062	%I	>
1063	%J	?
1064	%V	@
1065	A	A
1066	B	B
1067	C	C
1068	D	D
1069	E	E
1070	F	F
1071	G	G
1072	H	H
1073	I	I
1074	J	J
1075	K	K
1076	L	L
1077	M	M
1078	N	N
1079	O	O
1080	P	P
1081	Q	Q

<sup>1</sup>The keystroke in bold is sent only if the “Function Key Mapping” is enabled. Otherwise, the unbolded keystroke is sent.

**Table 17. ASCII Character Set for USB (Continued)**

ASCII Value	Full ASCII Code 39 Encode Character	Keystroke
1082	R	R
1083	S	S
1084	T	T
1085	U	U
1086	V	V
1087	W	W
1088	X	X
1089	Y	Y
1090	Z	Z
1091	%K	[
1092	%L	\
1093	%M	]
1094	%N	^
1095	%O	_
1096	%W	`
1097	+A	<b>a</b>
1098	+B	<b>b</b>
1099	+C	<b>c</b>
1100	+D	<b>d</b>
1101	+E	<b>e</b>
1102	+F	<b>f</b>
1103	+G	<b>g</b>
1104	+H	<b>h</b>
1105	+I	<b>i</b>
1106	+J	<b>j</b>
1107	+K	<b>k</b>
1108	+L	<b>l</b>
1109	+M	<b>m</b>

<sup>1</sup>The keystroke in bold is sent only if the "Function Key Mapping" is enabled. Otherwise, the unbolded keystroke is sent.

**Table 17. ASCII Character Set for USB (Continued)**

ASCII Value	Full ASCII Code 39 Encode Character	Keystroke
1110	+N	n
1111	+O	o
1112	+P	p
1113	+Q	q
1114	+R	r
1115	+S	s
1116	+T	t
1117	+U	u
1118	+V	v
1119	+W	w
1120	+X	x
1121	+Y	y
1122	+Z	z
1123	%P	{
1124	%Q	
1125	%R	}
1126	%S	~

<sup>1</sup>The keystroke in bold is sent only if the “Function Key Mapping” is enabled. Otherwise, the unbolded keystroke is sent.

**Table 18. USB ALT Key Character Set**

ALT Keys	Keystroke
2064	ALT 2
2065	ALT A
2066	ALT B
2067	ALT C
2068	ALT D
2069	ALT E
2070	ALT F

**Table 18. USB ALT Key Character Set (Continued)**

ALT Keys	Keystroke
2071	ALT G
2072	ALT H
2073	ALT I
2074	ALT J
2075	ALT K
2076	ALT L
2077	ALT M
2078	ALT N
2079	ALT O
2080	ALT P
2081	ALT Q
2082	ALT R
2083	ALT S
2084	ALT T
2085	ALT U
2086	ALT V
2087	ALT W
2088	ALT X
2089	ALT Y
2090	ALT Z

**Table 19. USB GUI Key Character Set**

GUI Key	Keystroke
3000	Right Control Key
3048	GUI 0
3049	GUI 1
3050	GUI 2
3051	GUI 3
3052	GUI 4

**Note:** GUI Shift Keys - The Apple™ iMac keyboard has an apple key on either side of the space bar. Windows-based systems have a GUI key to the left of the left ALT key, and to the right of the right ALT key.

**Table 19. USB GUI Key Character Set (Continued)**

GUI Key	Keystroke
3053	GUI 5
3054	GUI 6
3055	GUI 7
3056	GUI 8
3057	GUI 9
3065	GUI A
3066	GUI B
3067	GUI C
3068	GUI D
3069	GUI E
3070	GUI F
3071	GUI G
3072	GUI H
3073	GUI I
3074	GUI J
3075	GUI K
3076	GUI L
3077	GUI M
3078	GUI N
3079	GUI O
3080	GUI P
3081	GUI Q
3082	GUI R
3083	GUI S
3084	GUI T
3085	GUI U
3086	GUI V
3087	GUI W
<p><b>Note:</b> GUI Shift Keys - The Apple™ iMac keyboard has an apple key on either side of the space bar. Windows-based systems have a GUI key to the left of the left ALT key, and to the right of the right ALT key.</p>	



**Table 19. USB GUI Key Character Set (Continued)**

GUI Key	Keystroke
3088	GUI X
3089	GUI Y
3090	GUI Z

**Note:** GUI Shift Keys - The Apple™ iMac keyboard has an apple key on either side of the space bar. Windows-based systems have a GUI key to the left of the left ALT key, and to the right of the right ALT key.

**Table 20. USB F Key Character Set**

F Keys	Keystroke
5001	F1
5002	F2
5003	F3
5004	F4
5005	F5
5006	F6
5007	F7
5008	F8
5009	F9
5010	F10
5011	F11
5012	F12
5013	F13
5014	F14
5015	F15
5016	F16
5017	F17
5018	F18
5019	F19
5020	F20
5021	F21

**Table 20. USB F Key Character Set (Continued)**

F Keys	Keystroke
5022	F22
5023	F23
5024	F24

**Table 21. USB Numeric Keypad Character Set**

Numeric Keypad	Keystroke
6042	*
6043	+
6044	undefined
6045	-
6046	.
6047	/
6048	0
6049	1
6050	2
6051	3
6052	4
6053	5
6054	6
6055	7
6056	8
6057	9
6058	Enter
6059	Num Lock

**Table 22. USB Extended Keypad Character Set**

Extended Keypad	Keystroke
7001	Break
7002	Delete
7003	PgUp
7004	End
7005	Pg Dn

**Table 22. USB Extended Keypad Character Set (Continued)**

Extended Keypad	Keystroke
7006	Pause
7007	Scroll Lock
7008	Backspace
7009	Tab
7010	Print Screen
7011	Insert
7012	Home
7013	Enter
7014	Escape
7015	Up Arrow
7016	Down Arrow
7017	Left Arrow
7018	Right Arrow

# NOTES

# Chapter 9

## Symbologies

### Introduction

This chapter describes symbology features and provides the programming bar codes for selecting these features. Before programming, follow the instructions in [Chapter 2, Getting Started](#).

The scanner is shipped with the settings shown in [Table 23 on page 96](#) (also see [Appendix B, Standard Defaults](#) for all host device and miscellaneous defaults). If the default values suit requirements, programming is not necessary.

To set feature values, scan a single bar code or a short bar code sequence. The settings are stored in non-volatile memory and are preserved even when the scanner is powered down.

If not using a USB cable, select a host type (see each host chapter for specific host information) after the power-up beeps sound. This is only necessary upon the first power-up when connected to a new host.

To return all features to default values, scan the appropriate default bar code on [page 21](#). Throughout the programming bar code menus, default values are indicated with asterisks (\*).

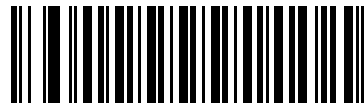

\* Indicates Default — \*Enable UPC-A — Feature/Option

### Scanning Sequence Examples

In most cases, scanning one bar code sets the parameter value. For example, to transmit bar code data without the UPC-A check digit, simply scan the [Do Not Transmit UPC-A Check Digit](#) bar code under [Transmit UPC-A Check Digit on page 104](#). The scanner issues a fast warble beep and the LED turns green, signifying a successful parameter entry. Other parameters, such as [Set Length\(s\) for D 2 of 5](#), require scanning several bar codes. See the individual parameter, such as [Set Length\(s\) for D 2 of 5](#), for this procedure.

### Errors While Scanning

Unless otherwise specified, to correct an error during a scanning sequence, just re-scan the correct parameter.

## Symbology Parameter Defaults

Table 23 lists the defaults for all symbologies parameters. To change any option, scan the appropriate bar code(s) provided in the Symbologies Parameters section beginning on page 99.



See Appendix B, Standard Defaults for all user preferences, hosts, symbologies, and miscellaneous default parameters.

### NOTE

**Table 23. Symbology Defaults**

Parameter	Default	Page Number
<b>UPC/EAN</b>		
UPC-A	Enable	99
UPC-E	Enable	99
UPC-E1	Disable	100
EAN-8/JAN 8	Enable	101
EAN-13/JAN 13	Enable	101
Bookland EAN	Disable	101
Decode UPC/EAN/JAN Supplementals (2 and 5 digits)	Ignore	103
Decode UPC/EAN/JAN Supplemental Redundancy	7	104
Transmit UPC-A Check Digit	Enable	104
Transmit UPC-E Check Digit	Enable	105
Transmit UPC-E1 Check Digit	Enable	105
UPC-A Preamble	System Character	106
UPC-E Preamble	System Character	107
UPC-E1 Preamble	System Character	108
Convert UPC-E to A	Disable	109
Convert UPC-E1 to A	Disable	109
EAN-8/JAN-8 Extend	Disable	110
UCC Coupon Extended Code	Disable	110
<b>Code 128</b>		
Code 128	Enable	111
UCC/EAN-128	Enable	111

**Table 23. Symbology Defaults (Continued)**

Parameter	Default	Page Number
ISBT 128 (non-concatenated)	Enable	112
<b>Code 39</b>		
Code 39	Enable	112
Trioptic Code 39	Disable	113
Convert Code 39 to Code 32 (Italian Pharmacy Code)	Disable	113
Code 32 Prefix	Disable	114
Set Length(s) for Code 39	2 to 55	115
Code 39 Check Digit Verification	Disable	116
Transmit Code 39 Check Digit	Disable	116
Code 39 Full ASCII Conversion	Disable	117
Buffer Code 39	Disable	118
<b>Code 93</b>		
Code 93	Disable	120
Set Length(s) for Code 93	4 to 55	122
<b>Code 11</b>		
Code 11	Disable	122
Set Lengths for Code 11	4 to 55	124
Code 11 Check Digit Verification	Disable	125
Transmit Code 11 Check Digit(s)	Disable	126
<b>Interleaved 2 of 5 (ITF)</b>		
Interleaved 2 of 5 (ITF)	Enable	126
Set Lengths for I 2 of 5	14	128
I 2 of 5 Check Digit Verification	Disable	129
Transmit I 2 of 5 Check Digit	Disable	129
Convert I 2 of 5 to EAN 13	Disable	130

**Table 23. Symbology Defaults (Continued)**

Parameter	Default	Page Number
<b>Discrete 2 of 5 (DTF)</b>		
Discrete 2 of 5	Disable	130
Set Length(s) for D 2 of 5	12	132
<b>Chinese 2 of 5</b>		
Enable/Disable Chinese 2 of 5	Disable	132
<b>Codabar (NW - 7)</b>		
Codabar	Disable	133
Set Lengths for Codabar	5 to 55	134
CLSI Editing	Disable	135
NOTIS Editing	Disable	136
<b>MSI</b>		
MSI	Disable	136
Set Length(s) for MSI	2 to 55	138
MSI Check Digits	One	138
Transmit MSI Check Digit	Disable	139
MSI Check Digit Algorithm	Mod 10/Mod 10	139
<b>GS1 DataBar (RSS)</b>		
DataBar Omnidirectional (RSS-14)	Disable	140
DataBar Limited	Disable	140
DataBar Expanded	Disable	140
Convert DataBar to UPC/EAN	Disable	141
<b>Symbology - Specific Security Levels</b>		
Redundancy Level	1	143
Security Levels	0	144
Bi-directional Redundancy	Disable	145



## UPC/EAN

### Enable/Disable UPC-A/UPC-E

To enable or disable UPC-A or UPC-E, scan the appropriate bar code below.

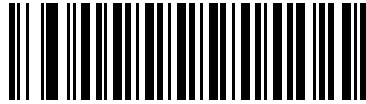

**\*Enable UPC-A**



**Disable UPC-A**

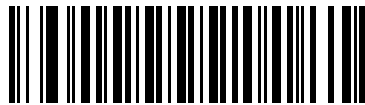

**\*Enable UPC-E**

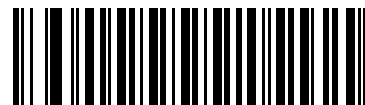

**Disable UPC-E**

## Enable/Disable UPC-E1

UPC-E1 is disabled by default.

To enable or disable UPC-E1, scan the appropriate bar code below.



UPC-E1 is not a UCC (Uniform Code Council) approved symbology.

### NOTE

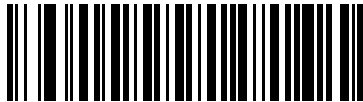

Enable UPC-E1



\*Disable UPC-E1

## Enable/Disable EAN-13/EAN-8

To enable or disable EAN-13 or EAN-8, scan the appropriate bar code below.

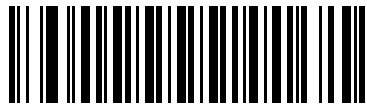

\*Enable EAN-13

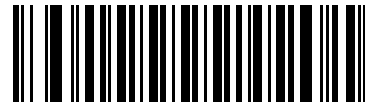

Disable EAN-13



\*Enable EAN-8

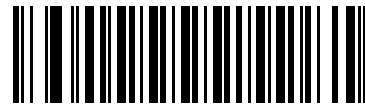

Disable EAN-8

## Enable/Disable Bookland EAN

To enable or disable Bookland EAN, scan the appropriate bar code below.

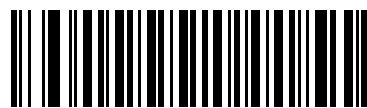

Enable Bookland EAN

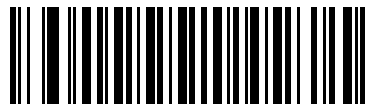

\*Disable Bookland EAN

## Decode UPC/EAN/JAN Supplementals

Supplementals are bar codes appended according to specific format conventions (e.g., UPC A+2, UPC E+2, EAN 13+2). Six options are available.

- If Decode UPC/EAN/JAN Only With Supplementals is selected, UPC/EAN bar codes without supplementals are not decoded.
- If Ignore Supplementals is selected, and the scanner is presented with a UPC/EAN/JAN with a supplemental, the UPC/EAN/JAN is decoded and the supplemental bar code is ignored.
- An Autodiscriminate Option is also available. If this option is selected, choose an appropriate value from the next page. A value of 5 or more is recommended.
- Select Enable 378/379 Supplemental Mode to delay only EAN-13/JAN-13 bar codes starting with a '378' or '379' prefix by the supplemental search process. All other UPC/EAN/JAN bar codes are exempted from the search and are reported instantly upon decode.
- Select Enable 978 Supplemental Mode to delay only EAN-13/JAN-13 bar codes starting with a '978' prefix by the supplemental search process. All other UPC/EAN bar codes are exempted from the search and are reported instantly upon their decode.
- Select Enable Smart Supplemental Mode to delay only EAN-13/JAN-13 bar codes starting with a '378', '379', or '978' prefix by the supplemental search process. All other UPC/EAN bar codes are exempted from the search and are reported instantly upon their decode.



**To minimize the risk of invalid data transmission, select either to decode or ignore supplemental characters.**

### NOTE

## Decode UPC/EAN/JAN Supplementals (continued)

 <p>Decode UPC/EAN/JAN Only With Supplementals</p>	
	 <p>*Ignore Supplementals</p>
 <p>Autodiscriminate UPC/EAN/JAN Supplementals</p>	
	 <p>Enable 378/379 Supplemental Mode</p>
 <p>Enable 978 Supplemental Mode</p>	
	 <p>Enable Smart Supplemental Mode</p>

## UPC/EAN/JAN Supplemental Redundancy

With Autodiscriminate UPC/EAN/JAN Supplementals selected, this option adjusts the number of times a bar code without supplementals is decoded before transmission. The range is from two to twenty-two times. Five or above is recommended when decoding a mix of UPC/EAN bar codes with and without supplementals, and the autodiscriminate option is selected. The default is set at seven.

Scan the bar code below to set a decode redundancy value. Next, scan two numeric bar codes in [Appendix E, Keypad](#). Single digit numbers must have a leading zero. To correct an error or change a selection, scan the CANCEL bar code located in [Appendix E, Keypad](#).

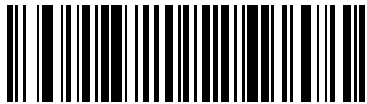

UPC/EAN/JAN Supplemental Redundancy

## Transmit UPC-A Check Digit

The check digit is the last character of the bar code used to verify the integrity of the data. Scan the appropriate bar code below to transmit the bar code data with or without the UPC-A check digit. It is always verified to guarantee the integrity of the data.

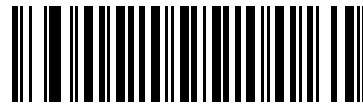

\*Transmit UPC-A Check Digit

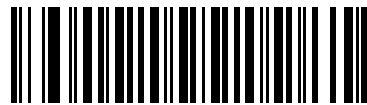

Do Not Transmit UPC-A Check Digit

## Transmit UPC-E Check Digit

The check digit is the last character of the bar code used to verify the integrity of the data. Scan the appropriate bar code below to transmit the bar code data with or without the UPC-E check digit. It is always verified to guarantee the integrity of the data.

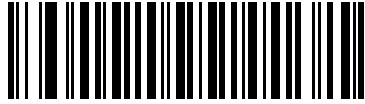

**\*Transmit UPC-E Check Digit**

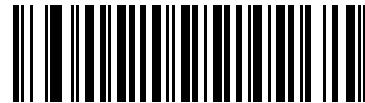

**Do Not Transmit UPC-E Check Digit**

## Transmit UPC-E1 Check Digit

The check digit is the last character of the bar code used to verify the integrity of the data. Scan the appropriate bar code below to transmit the bar code data with or without the UPC-E1 check digit. It is always verified to guarantee the integrity of the data.

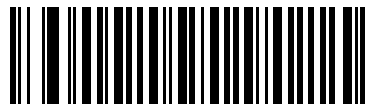

**\*Transmit UPC-E1 Check Digit**

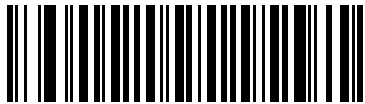

**Do Not Transmit UPC-E1 Check Digit**

## UPC-A Preamble

Preamble characters are part of the UPC bar code consisting of Country Code and System Character. Three options are given for transmitting UPC-A preamble to the host device: transmit System Character only, transmit System Character and Country Code (“0” for USA), and no preamble transmitted. Scan a bar code below to match the host system.



**No Preamble**  
(<DATA>)

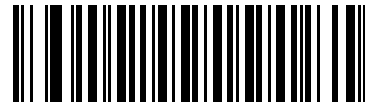

**\*System Character**  
(<SYSTEM CHARACTER> <DATA>)

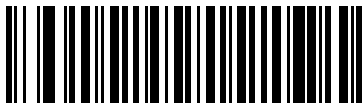

**System Character & Country Code**  
(< COUNTRY CODE> <SYSTEM CHARACTER> <DATA>)



## UPC-E Preamble

Preamble characters are part of the UPC bar code consisting of Country Code and System Character. Three options are given for transmitting UPC-E preamble to the host device: transmit System Character only, transmit System Character and Country Code (“0” for USA), and no preamble transmitted. Scan a bar code below to match the host system.



**No Preamble  
<DATA>**

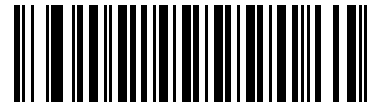

**\*System Character  
<SYSTEM CHARACTER> <DATA>**



**System Character & Country Code  
<COUNTRY CODE> <SYSTEM CHARACTER>  
<DATA>**

## UPC-E1 Preamble

Preamble characters are part of the UPC bar code consisting of Country Code and System Character. Three options are given for transmitting UPC-E1 preamble to the host device: transmit System Character only, transmit System Character and Country Code ("0" for USA), and no preamble transmitted. Scan a bar code below to match the host system.

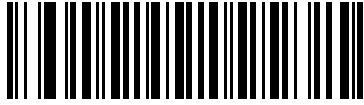

**No Preamble**  
(<DATA>)

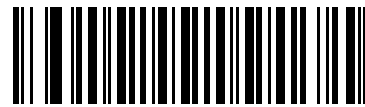

**\*System Character**  
(<SYSTEM CHARACTER> <DATA>)

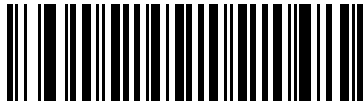

**System Character & Country Code**  
(< COUNTRY CODE> <SYSTEM CHARACTER> <DATA>)

## Convert UPC-E to UPC-A

Enable this to convert UPC-E (zero suppressed) decoded data to UPC-A format before transmission. After conversion, the data follows UPC-A format and is affected by UPC-A programming selections (e.g., Preamble, Check Digit).

When disabled, UPC-E decoded data is transmitted as UPC-E data, without conversion.

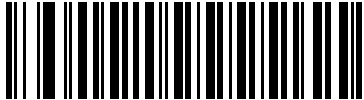
	 <p><b>Convert UPC-E to UPC-A (Enable)</b></p>
 <p><b>*Do Not Convert UPC-E to UPC-A (Disable)</b></p>	

## Convert UPC-E1 to UPC-A

Enable this to convert UPC-E1 decoded data to UPC-A format before transmission. After conversion, the data follows UPC-A format and is affected by UPC-A programming selections (e.g., Preamble, Check Digit).

When disabled, UPC-E1 decoded data is transmitted as UPC-E1 data, without conversion.

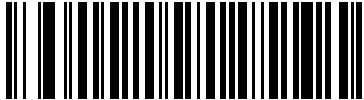
 <p><b>Convert UPC-E1 to UPC-A (Enable)</b></p>	
	 <p><b>*Do Not Convert UPC-E1 to UPC-A (Disable)</b></p>

## EAN-8/JAN-8 Extend

When enabled, this parameter adds five leading zeros to decoded EAN-8 bar codes to make them compatible in format to EAN-13 bar codes.  
 When disabled, EAN-8 bar codes are transmitted as is.



Enable EAN/JAN Zero Extend

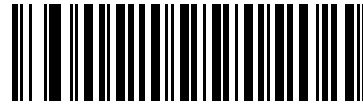

\*Disable EAN/JAN Zero Extend

## UCC Coupon Extended Code

When enabled, this parameter decodes UPCA bar codes starting with digit '5', EAN-13 bar codes starting with digit '99', and UPCA/EAN-128 Coupon Codes. UPCA, EAN-13 and EAN-128 must be enabled to scan all types of Coupon Codes.

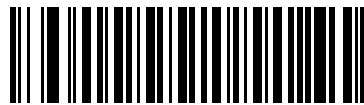

Enable UCC Coupon Extended Code

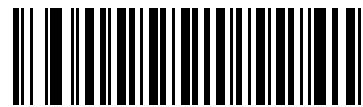

\*Disable UCC Coupon Extended Code



Use the Decode UPC/EAN Supplemental Redundancy parameter to control autodiscrimination of the EAN128 (right half) of a coupon code.

**NOTE**

## Code 128

### Enable/Disable Code 128

To enable or disable Code 128, scan the appropriate bar code below.



**\*Enable Code 128**



**Disable Code 128**

### Enable/Disable UCC/EAN-128

To enable or disable UCC/EAN-128, scan the appropriate bar code below.

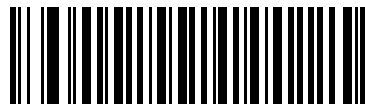

**\*Enable UCC/EAN-128**

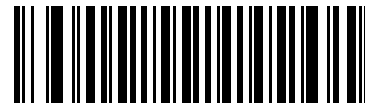

**Disable UCC/EAN-128**

## Enable/Disable ISBT 128

ISBT 128 is a variant of Code 128 used in the blood bank industry. Scan the appropriate bar code below to enable or disable ISBT 128. If necessary, the host must perform concatenation of the ISBT data.

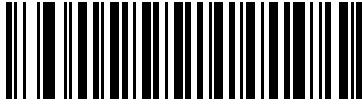

**\*Enable ISBT 128**

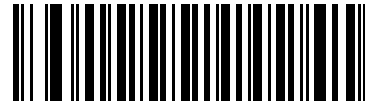

**Disable ISBT 128**

## Code 39

### Enable/Disable Code 39

To enable or disable Code 39, scan the appropriate bar code below.

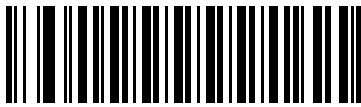

**\*Enable Code 39**

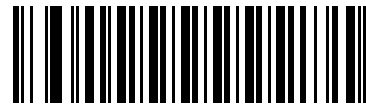

**Disable Code 39**

## Enable/Disable Trioptic Code 39

Trioptic Code 39 is a variant of Code 39 used in the marking of computer tape cartridges. Trioptic Code 39 bar codes always contain six characters. To enable or disable Trioptic Code 39, scan the appropriate bar code below.



Trioptic Code 39 and Code 39 Full ASCII cannot be enabled simultaneously.

### NOTE



Enable Trioptic Code 39

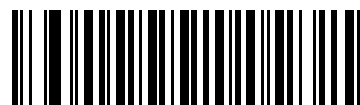

\*Disable Trioptic Code 39

## Convert Code 39 to Code 32

Code 32 is a variant of Code 39 used by the Italian pharmaceutical industry. Scan the appropriate bar code below to enable or disable converting Code 39 to Code 32.



Code 39 must be enabled for this parameter to function.

### NOTE



Enable Convert Code 39 to Code 32



\*Disable Convert Code 39 to Code 32

## Code 32 Prefix

Scan the appropriate bar code below to enable or disable adding the prefix character “A” to all Code 32 bar codes.



**Convert Code 39 to Code 32 must be enabled for this parameter to function.**

### NOTE

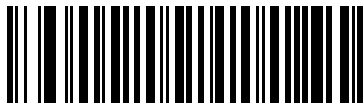

**Enable Code 32 Prefix**

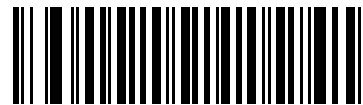

**\*Disable Code 32 Prefix**

## Set Lengths for Code 39

The length of a code refers to the number of characters (i.e., human readable characters), including check digit(s) the code contains. Set lengths for Code 39 to any length, one or two discrete lengths, or lengths within a specific range. If Code 39 Full ASCII is enabled, Length Within a Range or Any Length are the preferred options.



**When setting lengths for different bar code types by scanning single digit numbers, single digit numbers must always be preceded by a leading zero.**

### NOTE

- One Discrete Length - Select this option to decode only Code 39 bar codes containing a selected length. Select the length using the numeric bar codes in [Appendix E, Keypad](#). For example, to decode only Code 39 bar codes with 14 characters, scan Code 39 - One Discrete Length, then scan 1 followed by 4. To correct an error or change the selection, scan the CANCEL bar code located in [Appendix E, Keypad](#).
- Two Discrete Lengths - Select this option to decode only Code 39 bar codes containing either of two selected lengths. Select lengths using the numeric bar codes in [Appendix E, Keypad](#). For example, to decode only those Code 39 bar codes containing either 2 or 14 characters, select Code 39 - Two Discrete Lengths, then scan 0, 2, 1, and then 4. To correct an error or change the selection, scan the CANCEL bar code located in [Appendix E, Keypad](#).



## Set Lengths for Code 39 (continued)

- Length Within Range - Select this option to decode a Code 39 bar code with a specific length range. Select lengths using numeric bar codes in [Appendix E, Keypad](#). For example, to decode Code 39 bar codes containing between 4 and 12 characters, first scan Code 39 - Length Within Range. Then scan 0, 4, 1, and 2 (single digit numbers must always be preceded by a leading zero). To correct an error or change the selection, scan the CANCEL bar code located in [Appendix E, Keypad](#).
- Any Length - Select this option to decode Code 39 bar codes containing any number of characters within the scanner capability.



Code 39 - One Discrete Length



Code 39 - Two Discrete Lengths



Code 39 - Length Within Range



Code 39 - Any Length

## Code 39 Check Digit Verification

When this feature is enabled, the scanner checks the integrity of all Code 39 bar codes to verify that the data complies with specified check digit algorithm. Only Code 39 bar codes which include a modulo 43 check digit are decoded. Enable this feature if the Code 39 bar codes contain a Modulo 43 check digit.

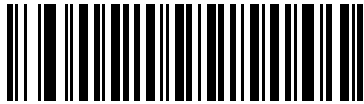

**Enable Code 39 Check Digit**

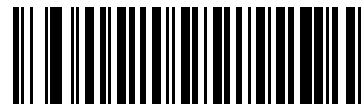

**\*Disable Code 39 Check Digit**

## Transmit Code 39 Check Digit

Scan the appropriate bar code below to transmit Code 39 data with or without the check digit.



**Code 39 Check Digit Verification must be enabled for this parameter to function.**

**NOTE**

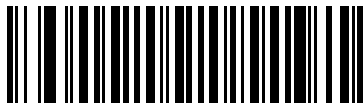

**Transmit Code 39 Check Digit  
(Enable)**



**\*Do Not Transmit Code 39 Check Digit  
(Disable)**

## Code 39 Full ASCII Conversion

Code 39 Full ASCII is a variant of Code 39 which pairs characters to encode the full ASCII character set. To enable or disable Code 39 Full ASCII, scan the appropriate bar code below.



### NOTE

Trioptic Code 39 and Code 39 Full ASCII cannot be enabled simultaneously.

Code 39 Full ASCII to Full ASCII Correlation is host-dependent and is described in the ASCII Character Set table for the appropriate interface. See [ASCII Character Set for Keyboard Wedge on page 64](#), [ASCII Character Set for RS-232 on page 49](#) and [ASCII Character Set for USB on page 84](#) for the appropriate interface.

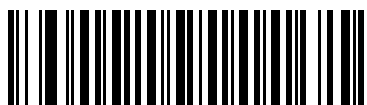

Enable Code 39 Full ASCII



\*Disable Code 39 Full ASCII

## Code 39 Buffering (Scan & Store)

This feature allows the scanner to accumulate data from multiple Code 39 bar codes. Selecting the Scan and Store option (Buffer Code 39) temporarily buffers all Code 39 bar codes having a leading space as a first character for later transmission. The leading space is not buffered.

Decode of a valid Code 39 bar code with no leading space causes transmission in sequence of all buffered data in a first-in first-out format, plus transmission of the “triggering” bar code. See the following pages for further details.

When the Do Not Buffer Code 39 option is selected, all decoded Code 39 bar codes are transmitted immediately without being stored in the buffer.

Code 39 Buffering (Scan & Store)

This feature affects Code 39 only. If selecting Buffer Code 39, we recommend configuring the scanner to decode Code 39 symbology only.

 <p style="text-align: center;"><b>Buffer Code 39 (Enable)</b></p>	
	 <p style="text-align: center;"><b>*Do Not Buffer Code 39 (Disable)</b></p>

While there is data in the transmission buffer, selecting Do Not Buffer Code 39 is not allowed. The buffer holds 200 bytes of information.

To disable Code 39 buffering when there is data in the transmission buffer, first force the buffer transmission (see [Transmit Buffer on page 119](#)) or clear the buffer.

### Buffer Data

To buffer data, Code 39 buffering must be enabled and a Code 39 bar code must be read with a space immediately following the start pattern.

- Unless the data overflows the transmission buffer, the scanner issues a low/high beep to indicate successful decode and buffering. (For overflow conditions, see [Overfilling Transmission Buffer on page 120](#).)
- The scanner adds the decoded data excluding the leading space to the transmission buffer.
- No transmission occurs.

## Clear Transmission Buffer



Because the Clear Buffer contains only the dash (minus) character, set the Code 39 length to include length 1 before scanning this bar code.

### NOTE

To clear the transmission buffer, scan the Clear Buffer bar code below, which contains only a start character, a dash (minus), and a stop character.

- The scanner issues a short high/low/high beep.
- The scanner erases the transmission buffer.
- No transmission occurs.



Clear Buffer

## Transmit Buffer



Because the Transmit Buffer contains only a plus (+) character, set the Code 39 length to include length 1 before scanning this bar code.

### NOTE

There are two methods to transmit the Code 39 buffer.

1. Scan the Transmit Buffer bar code below which contains only a start character, a plus (+), and a stop character.
  - The scanner transmits and clears the buffer.
  - The scanner issues a low/high beep.



Transmit Buffer

2. Scan a Code 39 bar code with a leading character other than a space.
  - The scanner appends new decode data to buffered data.
  - The scanner transmits and clears the buffer.
  - The scanner signals that the buffer was transmitted with a low/high beep.
  - Scanner transmits and clears the buffer.

### Overfilling Transmission Buffer

The Code 39 buffer holds 200 characters. If the bar code just read results in an overflow of the transmission buffer:

- The scanner indicates that the bar code was rejected by issuing three long, high beeps.
- No transmission occurs. The data in the buffer is not affected.

### Attempt to Transmit an Empty Buffer

If the bar code just read was the Transmit Buffer bar code and the Code 39 buffer is empty:

- A short low/high/low beep signals that the buffer is empty.
- No transmission occurs.
- The buffer remains empty.

## Code 93

### Enable/Disable Code 93

To enable or disable Code 93, scan the appropriate bar code below.

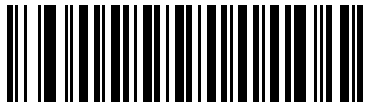

Enable Code 93

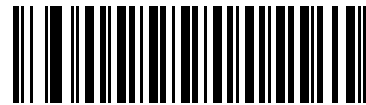

\*Disable Code 93

---

## Set Lengths for Code 93

The length of a code refers to the number of characters (i.e., human readable characters), including check digit(s) the code contains. Set lengths for Code 93 to any length, one or two discrete lengths, or lengths within a specific range.

- **One Discrete Length** - Select this option to decode only Code 93 bar codes containing a selected length. Select the length using the numeric bar codes in [Appendix E, Keypad](#). For example, to decode only Code 93 bar codes with 14 characters, scan Code 93 - One Discrete Length, then scan 1 followed by 4. To correct an error or to change the selection, scan the CANCEL bar code located in [Appendix E, Keypad](#).
- **Two Discrete Lengths** - Select this option to decode only Code 93 bar codes containing either of two selected lengths. Select lengths using the numeric bar codes in [Appendix E, Keypad](#). For example, to decode only those Code 93 bar codes containing either 2 or 14 characters, select Code 93 - Two Discrete Lengths, then scan 0, 2, 1, and then 4. To correct an error or to change the selection, scan the CANCEL bar code located in [Appendix E, Keypad](#).
- **Length Within Range** - Select this option to decode a Code 93 bar code with a specific length range. Select lengths using the numeric bar codes in [Appendix E, Keypad](#). For example, to decode Code 93 bar codes containing between 4 and 12 characters, first scan Code 93 - Length Within Range. Then scan 0, 4, 1, and 2 (single digit numbers must always be preceded by a leading zero). To correct an error or change the selection, scan the CANCEL bar code located in [Appendix E, Keypad](#).
- **Any Length** - Scan this option to decode Code 93 bar codes containing any number of characters within the scanner's capability.

## Set Lengths for Code 93 (continued)



Code 93 - One Discrete Length



Code 93 - Two Discrete Lengths



Code 93 - Length Within Range



Code 93 - Any Length

## Code 11

To enable or disable Code 11, scan the appropriate bar code below.

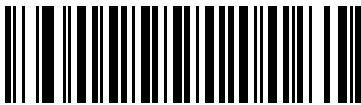

Enable Code 11



\*Disable Code 11



---

## Set Lengths for Code 11

The length of a code refers to the number of characters (i.e., human readable characters), including check digit(s) the code contains. Set lengths for Code 11 to any length, one or two discrete lengths, or lengths within a specific range.

- **One Discrete Length** - Select this option to decode only Code 11 bar codes containing a selected length. Select the length using the numeric bar codes in [Appendix E, Keypad](#). For example, to decode only Code 11 bar codes with 14 characters, scan Code 11 - One Discrete Length, then scan 1 followed by 4. To correct an error or to change the selection, scan the CANCEL bar code located in [Appendix E, Keypad](#).
- **Two Discrete Lengths** - Select this option to decode only Code 11 bar codes containing either of two selected lengths. Select lengths using the numeric bar codes in [Appendix E, Keypad](#). For example, to decode only those Code 11 bar codes containing either 2 or 14 characters, select Code 11 - Two Discrete Lengths, then scan 0, 2, 1, and then 4. To correct an error or to change the selection, scan the CANCEL bar code located in [Appendix E, Keypad](#).
- **Length Within Range** - Select this option to decode a Code 11 bar code with a specific length range. Select lengths using numeric bar codes in [Appendix E, Keypad](#). For example, to decode Code 11 bar codes containing between 4 and 12 characters, first scan Code 11 - Length Within Range. Then scan 0, 4, 1, and 2 (single digit numbers must always be preceded by a leading zero). To correct an error or change the selection, scan the CANCEL bar code located in [Appendix E, Keypad](#).
- **Any Length** - Scan this option to decode Code 11 bar codes containing any number of characters within the scanner capability.

## Set Lengths for Code 11 (continued)



Code 11 - One Discrete Length



Code 11 - Two Discrete Lengths



Code 11 - Length Within Range

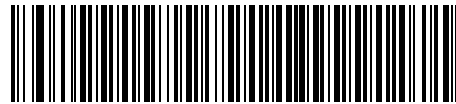



Code 11 - Any Length

## Code 11 Check Digit Verification

This feature allows the scanner to check the integrity of all Code 11 bar codes to verify that the data complies with the specified check digit algorithm. This selects the check digit mechanism for the decoded Code 11 bar code. The options are to check for one check digit, check for two check digits, or disable the feature.

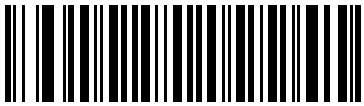
To enable this feature, scan the bar code below corresponding to the number of check digits encoded in your Code 11 bar codes.

 <b>*Disable</b>	
	 <b>One Check Digit</b>
 <b>Two Check Digits</b>	

## Transmit Code 11 Check Digits

This feature selects whether or not to transmit the Code 11 check digit(s).



Code 11 Check Digit Verification must be enabled for this parameter to function.

### NOTE

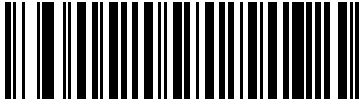
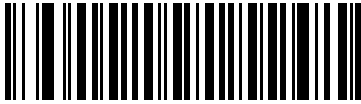
	 <p><b>Transmit Code 11 Check Digit(s) (Enable)</b></p>
 <p><b>*Do Not Transmit Code 11 Check Digit(s) (Disable)</b></p>	

## Interleaved 2 of 5 (ITF)

### Enable/Disable Interleaved 2 of 5

To enable or disable Interleaved 2 of 5, scan the appropriate bar code below, and select an Interleaved 2 of 5 length from the following pages.

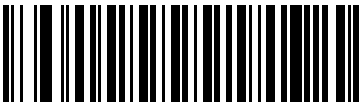
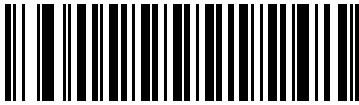
 <p><b>*Enable Interleaved 2 of 5</b></p>	
	 <p><b>Disable Interleaved 2 of 5</b></p>

## Set Lengths for Interleaved 2 of 5

The length of a code refers to the number of characters (i.e., human readable characters), including check digit(s) the code contains. Set lengths for I 2 of 5 to any length, one or two discrete lengths, or lengths within a specific range.

- **One Discrete Length** - Select this option to decode only I 2 of 5 bar codes containing a selected length. Select the length using the numeric bar codes in scan the CANCEL bar code located in [Appendix E, Keypad](#). For example, to decode only I 2 of 5 bar codes with 14 characters, scan I 2 of 5 - One Discrete Length, then scan 1 followed by 4. To correct an error or to change the selection, scan the CANCEL bar code located in [Appendix E, Keypad](#).
- **Two Discrete Lengths** - Select this option to decode only I 2 of 5 bar codes containing either of two selected lengths. Select lengths using the numeric bar codes in [Appendix E, Keypad](#). For example, to decode only those I 2 of 5 bar codes containing either 2 or 14 characters, select I 2 of 5 - Two Discrete Lengths, then scan 0, 2, 1, and then 4. To correct an error or to change the selection, scan the CANCEL bar code located in [Appendix E, Keypad](#).
- **Length Within Range** - Select this option to decode an I 2 of 5 bar code with a specific length range. Select lengths using numeric bar codes in [Appendix E, Keypad](#). For example, to decode I 2 of 5 bar codes containing between 4 and 12 characters, first scan I 2 of 5 - Length Within Range. Then scan 0, 4, 1, and 2 (single digit numbers must always be preceded by a leading zero). To correct an error or change the selection, can the CANCEL bar code located in [Appendix E, Keypad](#).
- **Any Length** - Scan this option to decode I 2 of 5 bar codes containing any number of characters within the scanner capability.



### NOTE

Due to the construction of the I 2 of 5 symbology, it is possible for a scan line covering only a portion of the code to be interpreted as a complete scan, yielding less data than is encoded in the bar code. To prevent this, select specific lengths (I 2 of 5 - One Discrete Length - Two Discrete Lengths) for I 2 of 5 applications.

## Set Lengths for Interleaved 2 of 5 (continued)



I 2 of 5 - One Discrete Length

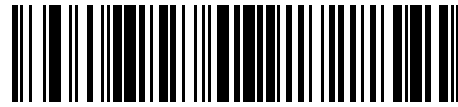

I 2 of 5 - Two Discrete Lengths

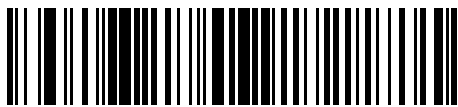

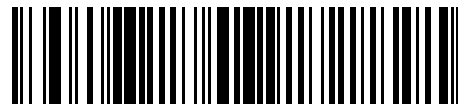

\*I 2 of 5 - Length Within Range  
(Default range is 2 to 55)



I 2 of 5 - Any Length

## I 2 of 5 Check Digit Verification

When this feature is enabled, the scanner checks the integrity of all I 2 of 5 bar codes to verify the data complies with either the specified Uniform Symbology Specification (USS), or the Optical Product Code Council (OPCC) check digit algorithm.

 <p><b>*Disable</b></p>	
	 <p><b>USS Check Digit</b></p>
 <p><b>OPCC Check Digit</b></p>	

## Transmit I 2 of 5 Check Digit

Scan the appropriate bar code below to transmit I 2 of 5 data with or without the check digit.

 <p><b>Transmit I 2 of 5 Check Digit (Enable)</b></p>	
	 <p><b>*Do Not Transmit I 2 of 5 Check Digit (Disable)</b></p>

## Convert I 2 of 5 to EAN-13

Enable this parameter to convert 14-character I 2 of 5 codes to EAN-13, and transmit to the host as EAN-13. To accomplish this, the I 2 of 5 code must be enabled, and the code must have a leading zero and a valid EAN-13 check digit.



**Convert I 2 of 5 to EAN-13  
(Enable)**

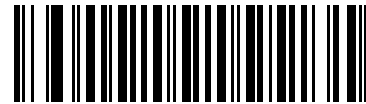

**\*Do Not Convert I 2 of 5 to EAN-13  
(Disable)**

## Discrete 2 of 5 (DTF)

### Enable/Disable Discrete 2 of 5

To enable or disable Discrete 2 of 5, scan the appropriate bar code below.

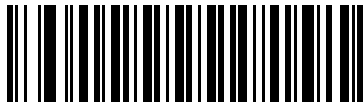

**Enable Discrete 2 of 5**

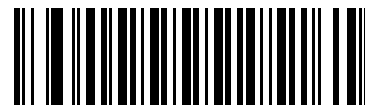

**\*Disable Discrete 2 of 5**



## Set Lengths for Discrete 2 of 5

The length of a code refers to the number of characters (i.e., human readable characters), including check digit(s) the code contains. Set lengths for D 2 of 5 to any length, one or two discrete lengths, or lengths within a specific range.



- One Discrete Length - Select this option to decode only D 2 of 5 bar codes containing a selected length. Select the length using the numeric bar codes in [Appendix E, Keypad](#). For example, to decode only D 2 of 5 bar codes with 14 characters, scan D 2 of 5 - One Discrete Length, then scan 1 followed by 4. To correct an error or to change the selection, scan the CANCEL bar code located in [Appendix E, Keypad](#).
- Two Discrete Lengths - Select this option to decode only D 2 of 5 bar codes containing either of two selected lengths. Select lengths using the numeric bar codes in [Appendix E, Keypad](#). For example, to decode only those D 2 of 5 bar codes containing either 2 or 14 characters, select D 2 of 5 - Two Discrete Lengths, then scan 0, 2, 1, and then 4. To correct an error or to change the selection, scan the CANCEL bar code located in [Appendix E, Keypad](#).
- Length Within Range - Select this option to decode a D 2 of 5 bar code with a specific length range. Select lengths using numeric bar codes in [Appendix E, Keypad](#). For example, to decode D 2 of 5 bar codes containing between 4 and 12 characters, first scan D 2 of 5 - Length Within Range. Then scan 0, 4, 1, and 2 (single digit numbers must always be preceded by a leading zero). To correct an error or change the selection, scan the CANCEL bar code located in [Appendix E, Keypad](#).
- Any Length - Scan this option to decode D 2 of 5 bar codes containing any number of characters within the scanner capability.



### NOTE

Due to the construction of the D 2 of 5 symbology, it is possible for a scan line covering only a portion of the code to be interpreted as a complete scan, yielding less data than is encoded in the bar code. To prevent this, select specific lengths (D 2 of 5 - One Discrete Length - Two Discrete Lengths) for D 2 of 5 applications.



## Set Lengths for Discrete 2 of 5 (continued)

 <p>D 2 of 5 - One Discrete Length</p>	
	 <p>D 2 of 5 - Two Discrete Lengths</p>
 <p>D 2 of 5 - Length Within Range</p>	
	 <p>D 2 of 5 - Any Length</p>

## Chinese 2 of 5

### Enable/Disable Chinese 2 of 5

To enable or disable Chinese 2 of 5, scan the appropriate bar code below.

 <p>Enable Chinese 2 of 5</p>	
	 <p>*Disable Chinese 2 of 5</p>

## Codabar (NW - 7)

### Enable/Disable Codabar

To enable or disable Codabar, scan the appropriate bar code below.

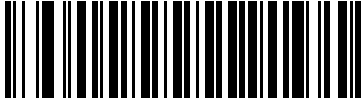
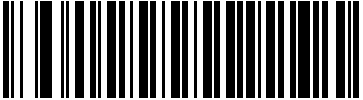
 <p>Enable Codabar</p>	
	 <p>*Disable Codabar</p>

### Set Lengths for Codabar

The length of a code refers to the number of characters (i.e., human readable characters), including check digit(s) the code contains. Set lengths for Codabar to any length, one or two discrete lengths, or lengths within a specific range.

- One Discrete Length - Select this option to decode only Codabar bar codes containing a selected length. Select the length using the numeric bar codes in [Appendix E, Keypad](#). For example, to decode only Codabar bar codes with 14 characters, scan Codabar - One Discrete Length, then scan 1 followed by 4. To correct an error or to change the selection, scan the CANCEL bar code located in [Appendix E, Keypad](#).
- Two Discrete Lengths - Select this option to decode only Codabar bar codes containing either of two selected lengths. Select lengths using the numeric bar codes in [Appendix E, Keypad](#). For example, to decode only Codabar bar codes containing either 2 or 14 characters, select Codabar - Two Discrete Lengths, then scan 0, 2, 1, and then 4. To correct an error or to change the selection, scan the CANCEL bar code located in [Appendix E, Keypad](#).
- Length Within Range - Select this option to decode a Codabar bar code with a specific length range. Select lengths using numeric bar codes in [Appendix E, Keypad](#). For example, to decode Codabar bar codes containing between 4 and 12 characters, first scan Codabar - Length Within Range. Then scan 0, 4, 1, and 2 (single digit numbers must always be preceded by a leading zero). To correct an error or change the selection, scan the CANCEL bar code located in [Appendix E, Keypad](#).
- Any Length - Scan this option to decode Codabar bar codes containing any number of characters within the scanner capability.

## Set Lengths for Codabar (continued)



Codabar - One Discrete Length



Codabar - Two Discrete Lengths



Codabar - Length Within Range



Codabar - Any Length

## CLSI Editing

When enabled, this parameter strips the start and stop characters and inserts a space after the first, fifth, and tenth characters of a 14-character Codabar bar code. Enable this feature if your host system requires this data format.



Bar Code length does not include start and stop characters.

### NOTE



Enable CLSI Editing

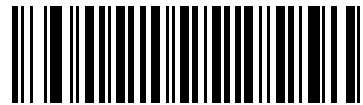

\*Disable CLSI Editing

## NOTIS Editing

When enabled, this parameter strips the start and stop characters from a decoded Codabar bar code. Enable this feature if your host system requires this data format.



Enable NOTIS Editing

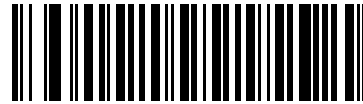

\*Disable NOTIS Editing

## MSI

### Enable/Disable MSI

To enable or disable MSI, scan the appropriate bar code below.

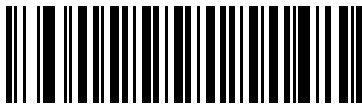

Enable MSI

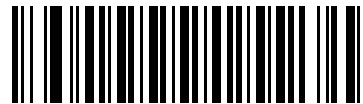

\*Disable MSI

## Set Lengths for MSI

The length of a code refers to the number of characters (i.e., human readable characters), including check digit(s) the code contains. Set lengths for MSI to any length, one or two discrete lengths, or lengths within a specific range.

- **One Discrete Length** - Select this option to decode only MSI bar codes containing a selected length. Select the length using the numeric bar codes in [Appendix E, Keypad](#). For example, to decode only MSI bar codes with 14 characters, scan MSI - One Discrete Length, then scan 1 followed by 4. To correct an error or to change the selection, scan the CANCEL bar code located in [Appendix E, Keypad](#).
- **Two Discrete Lengths** - Select this option to decode only MSI bar codes containing either of two selected lengths. Select lengths using the numeric bar codes in [Appendix E, Keypad](#). For example, to decode only MSI bar codes containing either 2 or 14 characters, select MSI - Two Discrete Lengths, then scan 0, 2, 1, and then 4. To correct an error or to change the selection, scan the CANCEL bar code located in [Appendix E, Keypad](#).
- **Length Within Range** - Select this option to decode a MSI bar code with a specific length range. Select lengths using numeric bar codes in [Appendix E, Keypad](#). For example, to decode MSI bar codes containing between 4 and 12 characters, first scan MSI - Length Within Range. Then scan 0, 4, 1, and 2 (single digit numbers must always be preceded by a leading zero). To correct an error or change the selection, scan the CANCEL bar code located in [Appendix E, Keypad](#).
- **Any Length** - Scan this option to decode MSI bar codes containing any number of characters within the scanner capability.



### NOTE

Due to the construction of the MSI symbology, it is possible for a scan line covering only a portion of the code to be interpreted as a complete scan, yielding less data than is encoded in the bar code. To prevent this, select specific lengths (MSI - One Discrete Length - Two Discrete Lengths) for MSI applications.

## Set Lengths for MSI (continued)

 <p>MSI - One Discrete Length</p>	
	 <p>MSI - Two Discrete Lengths</p>
 <p>MSI - Length Within Range</p>	
	 <p>*MSI - Any Length</p>

## MSI Check Digits

With MSI bar codes, one check digit is mandatory and always verified by the reader. The second check digit is optional. If the MSI codes include two check digits, scan the Two MSI Check Digits bar code to enable verification of the second check digit. See [MSI Check Digit Algorithm on page 139](#) for the selection of second digit algorithms.

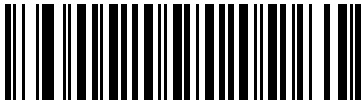
 <p>*One MSI Check Digit</p>	
	 <p>Two MSI Check Digits</p>



## Transmit MSI Check Digit(s)

Scan the appropriate bar code below to transmit MSI data with or without the check digit.



**Transmit MSI Check Digit(s)  
(Enable)**

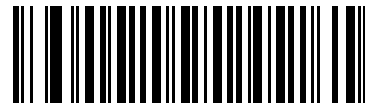

**\*Do Not Transmit MSI Check Digit(s)  
(Disable)**

## MSI Check Digit Algorithm

Two algorithms are possible for the verification of the second MSI check digit. Select the bar code below corresponding to the algorithm used to encode your check digit.

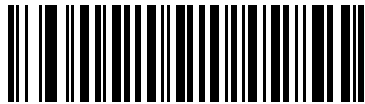

**MOD 10/MOD 11**

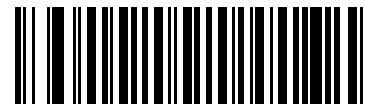

**\*MOD 10/MOD 10**

## GS1 DataBar (RSS)

The variants of GS1 DataBar are DataBar Omnidirectional, DataBar Expanded and DataBar Limited.



**NOTE**

The GS1 DataBar symbology family was formerly known as RSS. Equivalents for each variant in the family are:

RSS-14 = DataBar Omnidirectional

RSS Expanded = DataBar Expanded

RSS Limited = DataBar Limited

DataBar Omnidirectional and DataBar Expanded include stacked versions. Scan the appropriate bar code below to enable or disable each variant of DataBar.

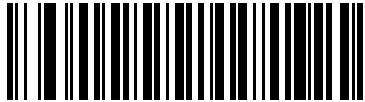

Enable DataBar Omnidirectional

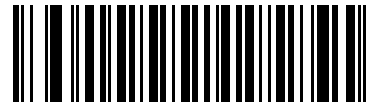

\*Disable DataBar Omnidirectional

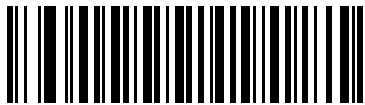

Enable DataBar Limited



\*Disable DataBar Limited



Enable DataBar Expanded





\*Disable DataBar Expanded

## Convert DataBar to UPC/EAN

This parameter only applies to DataBar Omnidirectional and DataBar Limited bar codes not decoded as part of a Composite bar code. Enable this to strip the leading '010' from DataBar Omnidirectional and DataBar Limited bar codes encoding a single zero as the first digit, and report the bar code as EAN-13.

For bar codes beginning with two or more zeros but not six zeros, this parameter strips the leading '0100' and reports the bar code as UPC-A. The UPC-A Preamble parameter that transmits the system character and country code applies to converted bar codes.

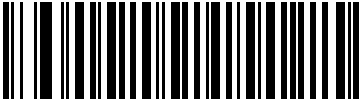
Note that neither the system character nor the check digit can be stripped.

 <p><b>Enable Convert DataBar to UPC/EAN</b></p>	
	 <p><b>*Disable Convert DataBar to UPC/EAN</b></p>

## Symbology - Specific Security Levels

### Redundancy Level

The scanner offers four levels of decode redundancy. Select higher redundancy levels for decreasing levels of bar code quality. As redundancy levels increase, the scanner's aggressiveness decreases.

Select the redundancy level appropriate for the bar code quality.

#### Redundancy Level 1

The following code types must be successfully read twice before being decoded:

**Table 24. Redundancy Level 1 Code Types**

Code Type	Code Length
Codabar	8 characters or less
MSI	4 characters or less
D 2 of 5	8 characters or less
I 2 of 5	8 characters or less

#### Redundancy Level 2

The following code types must be successfully read twice before being decoded:

**Table 25. Redundancy Level 2 Code Types**

Code Type	Code Length
All	All

#### Redundancy Level 3

Code types other than the following must be successfully read twice before being decoded. The following codes must be read three times:

**Table 26. Redundancy Level 3 Code Types**

Code Type	Code Length
MSI	4 characters or less
D 2 of 5	8 characters or less
I 2 of 5	8 characters or less
Codabar	8 characters or less

## Redundancy Level 4

The following code types must be successfully read three times before being decoded:

**Table 27. Redundancy Level 4 Code Types**

Code Type	Code Length
All	All

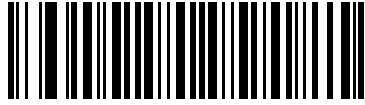

\*Redundancy Level 1

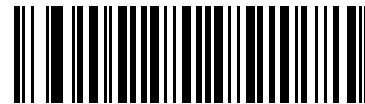

Redundancy Level 2

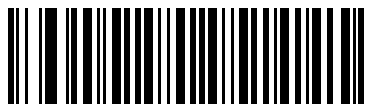

Redundancy Level 3



Redundancy Level 4

## Security Level

The scanner offers four levels of decode security for delta bar codes, which include the Code 128 family, UPC/EAN, and Code 93. Select increasing levels of security for decreasing levels of bar code quality. There is an inverse relationship between security and scanner aggressiveness, so choose only that level of security necessary for any given application.

- Security Level 0: This default setting allows the scanner to operate in its most aggressive state, while providing sufficient security in decoding most “in-spec” bar codes.
- Security Level 1: Select this option if misdecodes occur. This security level should eliminate most misdecodes.
- Security Level 2: Select this option if Security level 1 fails to eliminate misdecodes.
- Security Level 3: If Security Level 2 was selected and misdecodes still occur, select this security level. Be advised, selecting this option is an extreme measure against mis-decoding severely out of spec bar codes. Selecting this level of security significantly impairs the decoding ability of the scanner. If this level of security is necessary, try to improve the quality of the bar codes.

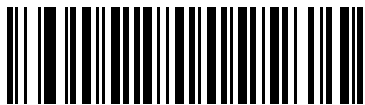

**\*Security Level 0**

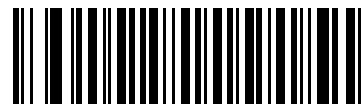

**Security Level 1**

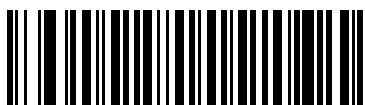

**Security Level 2**



**Security Level 3**

**Bi-directional Redundancy**

Enable Bi-directional Redundancy to add security to linear code type security levels. When enabled, a bar code must be successfully scanned in both directions (forward and reverse) before reporting a good decode.

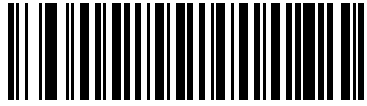
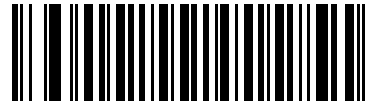
**Enable Bi-directional Redundancy****\*Disable Bi-directional Redundancy**

## Symbology - Intercharacter Gap

The Code 39 and Codabar bar codeologies have an intercharacter gap that is customarily quite small. Due to various bar code printing technologies, this gap may grow larger than the maximum size allowed, causing the scanner to be unable to decode the bar code. If this problem is encountered, scan Large Intercharacter Gaps to tolerate out-of-specification bar codes.



**\*Normal Intercharacter Gaps**



**Large Intercharacter Gaps**



# Appendix A

## Technical Specifications

Table 28 contains Physical and Performance Characteristics, User Environment and Regulatory information. Table 29 provides Standard Cable Pinouts.

**Table 28. Technical Specifications**

Item	Description
<b>Physical Characteristics</b>	
Dimensions	2.79 in. H x 6.71 in. L x 2.59 in. W (7.09 cm H x 17.04 cm L x 6.69 cm W)
Weight (without cable)	Approximately 4.5 oz. (128 g)
Voltage & Current	5.0 VDC +/-10% Standby: <35mA Operating: 100mA Max: 175mA
Color	Black or White
<b>Performance Characteristics</b>	
Light Source (Laser)	650nm laser diode
Scan Rate	100 scans per second
Scan Width	47°
Roll (Tilt) Tolerance	± 30° from normal
Pitch Tolerance	± 65°
Skew (Yaw) Tolerance	± 60°
Typical DOF Distance	13 mil (100% UPC/EAN): 0 to 9 in. (22.86 cm) 5 mil (Code 39): 0.5 to 5.5 in. (1.27 cm to 13.97 cm) (See <a href="#">Depth of Field on page 14.</a> )
Print Contrast Minimum	30% minimum reflectance
Decode Capability	UPC/EAN, UPC/EAN with Supplementals, UCC/EAN 128, Code 39, Code 39 Full ASCII, Code 39 TriOptic, Code 128, Code 128 Full ASCII, Codabar, Interleaved 2 of 5, Discrete 2 of 5, Code 93, MSI, Code 11, IATA, GS1 DataBar (RSS) variants, Chinese 2 of 5
Interfaces Supported	RS-232; Keyboard Wedge; USB

Item	Description
<b>User Environment</b>	
Operating Temperature	32° to 122° F (0° to 50° C)
Storage Temperature	-40° to 158° F (-40° to 70° C)
Humidity	5% to 95% relative humidity, non-condensing
Drop Specifications	Withstands multiple 5 ft./1.524 m drops to concrete.
Ambient Light Immunity	Immune to direct exposure of normal office and factory lighting conditions, as well as direct exposure to sunlight.
Beeper Volume	User-selectable: three levels
Beeper Tone	User-selectable: three tones
Electrostatic Discharge	Conforms to ±20 kV air/direct discharge and ±8 kV of contact discharge.
<b>Regulatory</b>	
Electrical Safety	UL 60950, CAN/CSA-C22.2 No. 60950, EN60950/IEC950
EMI/RFI	FCC Part 15 Class B, ICES-003 Class B, European Union EMC Directive, Australian SMA, Taiwan EMC, Japan VCCI/MITI
Laser Safety	IEC Class 2 Complies with 21 CFR 1040.10 and 1040.11, except for deviation pursuant to Laser Notice 50, dated June 24, 2007. IEC/EN60825-1:2007



**Laser light — Do not stare into beam.**

**CAUTION**

## Standard Cable Pinouts

Figure 13 and Table 29 provide standard pinout information for the scanner's cable.

**Figure 13. Standard Cable Pinouts**

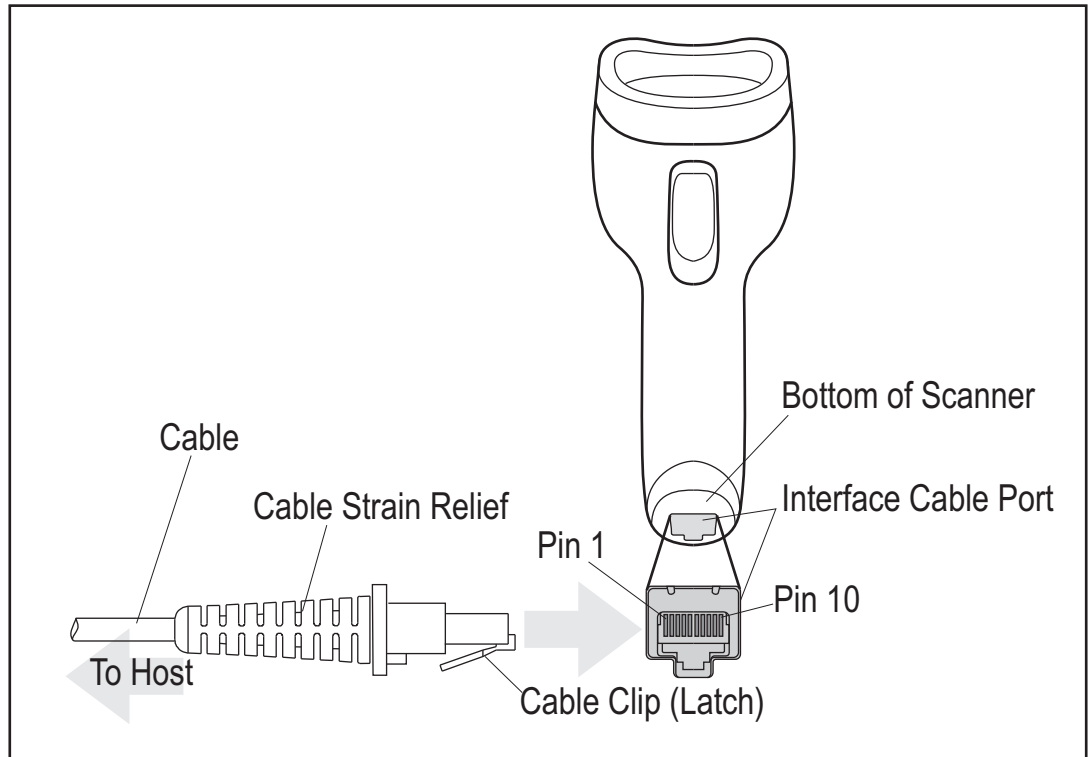

---

The signal descriptions in [Table 29](#) apply to the connector on the scanner and are for reference only.

**Table 29 Standard Cable Pinouts**

Pin	RS-232	Keyboard Wedge	USB
1	RTS	nc	Jump to Pin 5
2	nc	Clk In	D+
3	nc	Data In	D-
4	Ground	Ground	Ground
5	RXD	nc	Jump to Pin 1
6	TXD	nc	nc
7	Power	Power	Power
8	nc	Clk Out	nc
9	nc	Data Out	nc
10	CTS	nc	nc

# Appendix B

## Standard Defaults

The most common configuration settings are listed in the “Default” column of the table below. Page references are also provided for feature descriptions and programming bar codes for each parameter. A column has also been provided for recording of your preferred default settings for these same configurable features.

**Table 30. Standard Defaults**

Parameter	Default	Your Setting	Page Number
<b>General Features</b>			
Set Default Parameter	Restore Defaults		21
Beeper Tone	Medium		22
Beeper Volume	High		22
Power Mode	Continuous On		23
Scan Line Width	Full Width		25
Laser On Time	3.0 Sec		25
Beep After Good Read	Enable		26
Transmit Label ID	None		26
Global Prefix/Suffix	Data As Is		28
Prefix Value	7013 <CR><LF>		29
Suffix Value	7013 <CR><LF>		29
FN1 Substitution Values	Set		30
Transmit “No Read” Message	Disable		30
<b>Keyboard Wedge Host Parameters</b>			
Keyboard Wedge Host Type	IBM PC/AT& IBM PC Compatibles <sup>1</sup>		57
Country Types (Country Codes)	North American		58
Ignore Unknown Characters	Send		59
<sup>1</sup> User selection is required to configure this interface and this is the most common selection.			

Parameter	Default	Your Setting	Page Number
Keystroke Delay	No Delay		60
Intra-Keystroke Delay	Disable		60
Alternate Numeric Keypad Emulation	Disable		61
Caps Lock On	Disable		61
Caps Lock Override	Disable		62
Convert Wedge Data	No Convert		62
Function Key Mapping	Disable		63
FN1 Substitution	Disable		63
Send and Make Break	Send		63
<b>RS-232 Host Parameters</b>			
RS-232 Host Types	Standard		36
Baud Rate	9600		37
Parity Type	None		38
Stop Bit Select	1 Stop Bit		39
Data Bits (ASCII Format)	8-Bit		39
Check Receive Errors	Enable		40
Hardware Handshaking	None		41
Software Handshaking	None		43
Host Serial Response Time-out	2 Sec		45
RTS Line State	Low RTS		46
Beep on <BEL>	Disable		46
Intercharacter Delay	0 msec		47
Nixdorf Beep/LED Options	Normal Operation		48
Ignore Unknown Characters	Send Bar Code		48
<b>USB Host Parameters</b>			
USB Device Type	HID Keyboard Emulation		77
USB Country Keyboard Types (Country Codes)	North American		78
USB Keystroke Delay	No Delay		80
<sup>1</sup> User selection is required to configure this interface and this is the most common selection.			

Parameter	Default	Your Setting	Page Number
USB CAPS Lock Override	Disable		80
USB Ignore Unknown Characters	Send		81
Emulate Keypad	Disable		81
USB FN1 Substitution	Disable		82
Function Key Mapping	Disable		82
Simulated Caps Lock	Disable		83
Convert Case	No Case Conversion		83
<b>UPC/EAN</b>			
UPC-A	Enable		99
UPC-E	Enable		99
UPC-E1	Disable		100
EAN-8/JAN 8	Enable		101
EAN-13/JAN 13	Enable		101
Bookland EAN	Disable		101
Decode UPC/EAN/JAN Supplementals (2 and 5 digits)	Ignore		102
Decode UPC/EAN/JAN Supplemental Redundancy	7		104
Transmit UPC-A Check Digit	Enable		104
Transmit UPC-E Check Digit	Enable		105
Transmit UPC-E1 Check Digit	Enable		105
UPC-A Preamble	System Character		106
UPC-E Preamble	System Character		107
UPC-E1 Preamble	System Character		108
Convert UPC-E to A	Disable		109
Convert UPC-E1 to A	Disable		109
EAN-8/JAN-8 Extend	Disable		110
UCC Coupon Extended Code	Disable		110
<b>Code 128</b>			
Code 128	Enable		111
<sup>1</sup> User selection is required to configure this interface and this is the most common selection.			

Parameter	Default	Your Setting	Page Number
UCC/EAN-128	Enable		111
ISBT 128 (non-concatenated)	Enable		112
<b>Code 39</b>			
Code 39	Enable		112
Trioptic Code 39	Disable		113
Convert Code 39 to Code 32 (Italian Pharmacy Code)	Disable		113
Code 32 Prefix	Disable		114
Set Length(s) for Code 39	2 to 55		114
Code 39 Check Digit Verification	Disable		116
Transmit Code 39 Check Digit	Disable		116
Code 39 Full ASCII Conversion	Disable		117
Buffer Code 39	Disable		118
<b>Code 93</b>			
Code 93	Disable		120
Set Length(s) for Code 93	4 to 55		121
<b>Code 11</b>			
Code 11	Disable		122
Set Lengths for Code 11	4 to 55		123
Code 11 Check Digit Verification	Disable		125
Transmit Code 11 Check Digit(s)	Disable		126
<b>Interleaved 2 of 5 (ITF)</b>			
Interleaved 2 of 5 (ITF)	Enable		126
Set Lengths for I 2 of 5	14		127
I 2 of 5 Check Digit Verification	Disable		129
Transmit I 2 of 5 Check Digit	Disable		129
Convert I 2 of 5 to EAN 13	Disable		130
<b>Discrete 2 of 5 (DTF)</b>			
Discrete 2 of 5	Disable		130
Set Length(s) for D 2 of 5	12		131
<sup>1</sup> User selection is required to configure this interface and this is the most common selection.			



Parameter	Default	Your Setting	Page Number
<b>Chinese 2 of 5</b>			
Enable/Disable Chinese 2 of 5	Disable		132
<b>Codabar (NW - 7)</b>			
Codabar	Disable		133
Set Lengths for Codabar	5 to 55		133
CLSI Editing	Disable		135
NOTIS Editing	Disable		136
<b>MSI</b>			
MSI	Disable		136
Set Length(s) for MSI	2 to 55		137
MSI Check Digits	One		138
Transmit MSI Check Digit	Disable		139
MSI Check Digit Algorithm	Mod 10/Mod 10		139
<b>GS1 DataBar (RSS)</b>			
DataBar Omnidirectional (RSS -14)	Disable		140
DataBar Limited	Disable		140
DataBar Expanded	Disable		140
Convert DataBar to UPC/EAN	Disable		141
<b>Symbology - Specific Security Levels</b>			
Redundancy Level	1		142
Security Levels	0		144
Bi-directional Redundancy	Disable		145
<sup>1</sup> User selection is required to configure this interface and this is the most common selection.			

---

# NOTES

# Appendix C

## Programming Reference

### Datalogic Label ID Identifiers

Table 31. Symbology Characters

Code Character	Code Type
A	UPC/EAN
B	Code 39, Code 39 Full ASCII, Code 32
C	Codabar
D	Code 128, ISBT 128
E	Code 93
F	Interleaved 2 of 5
G	Discrete 2 of 5, or Discrete 2 of 5 IATA
H	Code 11
J	MSI
K	UCC/EAN-128
L	Bookland EAN
M	Trioptic Code 39
N	Coupon Code
R	GS1 DataBar (RSS) Family

### AIM Label ID Identifiers

Each AIM label ID Identifier contains the three-character string ]cm where:

] = Flag Character (ASCII 93)

c = Code Character (see [Table 32](#))

m = Modifier Character (see [Table 33](#))

**Table 32. Aim Label ID Characters**

Code Character	Code Type
A	Code 39, Code 39 Full ASCII, Code 32
C	Code 128 (all variants), Coupon (Code 128 portion)
E	UPC/EAN, Coupon (UPC portion)
e	GS1 DataBar (RSS) Family
F	Codabar
G	Code 93
H	Code 11
I	Interleaved 2 of 5
M	MSI
S	D2 of 5, IATA 2 of 5
X	Bookland EAN, Code 39 Trioptic

The modifier character is the sum of the applicable option values based on [Table 33](#).

**Table 33. Modifier Characters**

Code Type	Option Value	Option
Code 39	0	No check character or Full ASCII processing.
	1	Reader has checked one check character.
	3	Reader has checked and stripped check character.
	4	Reader has performed Full ASCII character conversion.
	5	Reader has performed Full ASCII character conversion and checked one check character.
	7	Reader has performed Full ASCII character conversion and checked and stripped check character.
	Example: A Full ASCII bar code with check character W, <b>A+I+MI+DW</b> , is transmitted as <b>JA7AIMID</b> where 7 = (3+4).	
Trioptic Code 39	0	No option specified at this time. Always transmit 0.
	Example: A Trioptic bar code 412356 is transmitted as <b>JX0412356</b>	

**Table 33. Modifier Characters (Continued)**

Code Type	Option Value	Option
Code 128	0	Standard data packet, no Function code 1 in first bar code position.
	1	Function code 1 in first bar code character position.
	2	Function code 1 in second bar code character position.
	Example: A Code (EAN) 128 bar code with Function 1 character <b>FNC1</b> in the first position, AIMID is transmitted as <b>JC1AIMID</b>	
I 2 of 5	0	No check digit processing.
	1	Reader has validated check digit.
	3	Reader has validated and stripped check digit.
	Example: An I 2 of 5 bar code without check digit, 4123, is transmitted as <b>JI04123</b>	
Codabar	0	No check digit processing.
	1	Reader has checked check digit.
	3	Reader has stripped check digit before transmission.
	Example: A Codabar bar code without check digit, 4123, is transmitted as <b>JF04123</b>	
Code 93	0	No options specified at this time. Always transmit 0.
	Example: A Code 93 bar code 012345678905 is transmitted as <b>JG0012345678905</b>	
MSI	0	Check digits are sent.
	1	No check digit is sent.
	Example: An MSI bar code 4123, with a single check digit checked, is transmitted as <b>JM14123</b>	
D 2 of 5	0	No options specified at this time. Always transmit 0.
	Example: A D 2 of 5 bar code 4123, is transmitted as <b>JS04123</b>	
UPC/EAN	0	Standard packet in full EAN country code format, which is 13 digits for UPC-A and UPC-E (not including supplemental data).
	1	Two-digit supplement data only.
	2	Five-digit supplement data only.
	4	EAN-8 data packet.
	Example: A UPC-A bar code 012345678905 is transmitted as <b>JE00012345678905</b>	
Bookland EAN	0	No options specified at this time. Always transmit 0.
	Example: A Bookland EAN bar code 123456789X is transmitted as <b>JX0123456789X</b>	

**Table 33. Modifier Characters (Continued)**

Code Type	Option Value	Option
Code 11	0	Single check digit
	1	Two check digits
	3	Check characters validated but not transmitted.
GS1 DataBar (RSS) Family		No option specified at this time. Always transmit 0. DataBar Omnidirectional (RSS-14) and DataBar Limited transmit with an Application Identifier "01". Note: In UCC/EAN-128 emulation mode, DataBar is transmitted using Code 128 rules (i.e., J̄C1).
		Example: A DataBar Omnidirectional bar code 100123456788902 is transmitted as <b>je</b> 001100123456788902.

# Appendix D

## Sample Bar Codes

---

The sample bar codes in this appendix are typical representations for their symbology types.

### UPC/EAN

#### UPC-A, 100%



#### EAN-13, 100%



### Code 128



---

## Sample Bar Codes — continued

### Code 39



### Code 93



### Code 11



### Interleaved 2 of 5





## Discrete 2 of 5 (DTF)



## Chinese 2 of 5



## Codabar



## MSI



---

## DataBar (RSS)



DataBar variants must be enabled to read the bar codes below (see [GS1 DataBar \(RSS\)](#) on page 140).

### NOTE



10293847560192837465019283746029478450366523  
(DataBar Expanded Stacked)



1234890hjo9900mnb  
(DataBar Expanded)



08672345650916  
(DataBar Limited)

## DataBar Omnidirectional



55432198673467  
(DataBar Omnidirectional Truncated)



90876523412674  
(DataBar Omnidirectional Stacked)









78123465709811  
(DataBar Stacked Omnidirectional)

# Appendix E

## Keypad

Use the bar codes in this appendix to enter numbers as you would select digits/characters from a keypad.

 0	
	 1
 2	
	 3
 4	
	 5



6



7



8



9

## Cancel

To correct an error or change a selection, scan the bar code below.



Cancel

# Appendix F

## ASCII Character Sets

**Table 34. ASCII Value - Code 39 Encode - Keystroke**

ASCII Value	Full ASCII Code 39 Encode Character	Keystroke
1000	%U	CTRL 2
1001	\$A	CTRL A
1002	\$B	CTRL B
1003	\$C	CTRL C
1004	\$D	CTRL D
1005	\$E	CTRL E
1006	\$F	CTRL F
1007	\$G	CTRL G
1008	\$H	CTRL H/ <b>BACKSPACE</b> <sup>1</sup>
1009	\$I	CTRL I/ <b>HORIZONTAL TAB</b> <sup>1</sup>
1010	\$J	CTRL J
1011	\$K	CTRL K
1012	\$L	CTRL L
1013	\$M	CTRL M/ <b>ENTER</b> <sup>1</sup>
1014	\$N	CTRL N
1015	\$O	CTRL O
1016	\$P	CTRL P
1017	\$Q	CTRL Q
1018	\$R	CTRL R
1019	\$S	CTRL S
1020	\$T	CTRL T
1021	\$U	CTRL U

**Table 34. ASCII Value - Code 39 Encode - Keystroke (Continued)**

ASCII Value	Full ASCII Code 39 Encode Character	Keystroke
1022	\$V	CTRL V
1023	\$W	CTRL W
1024	\$X	CTRL X
1025	\$Y	CTRL Y
1026	\$Z	CTRL Z
1027	%A	CTRL [
1028	%B	CTRL \
1029	%C	CTRL ]
1030	%D	CTRL 6
1031	%E	CTRL -
1032	Space	Space
1033	/A	!
1034	/B	"
1035	/C	#
1036	/D	?
1037	/E	%
1038	/F	&
1039	/G	'
1040	/H	(
1041	/I	)
1042	/J	*
1043	/K	+
1044	/L	,
1045	-	-
1046	.	.
1047	/o	/
1048	0	0
1049	1	1
1050	2	2
1051	3	3

**Table 34. ASCII Value - Code 39 Encode - Keystroke (Continued)**

ASCII Value	Full ASCII Code 39 Encode Character	Keystroke
1052	4	4
1053	5	5
1054	6	6
1055	7	7
1056	8	8
1057	9	9
1058	/Z	:
1059	%F	;
1060	%G	<
1061	%H	=
1062	%I	>
1063	%J	?
1064	%V	@
1065	A	A
1066	B	B
1067	C	C
1068	D	D
1069	E	E
1070	F	F
1071	G	G
1072	H	H
1073	I	I
1074	J	J
1075	K	K
1076	L	L
1077	M	M
1078	N	N
1079	O	O
1080	P	P
1081	Q	Q

**Table 34. ASCII Value - Code 39 Encode - Keystroke (Continued)**

ASCII Value	Full ASCII Code 39 Encode Character	Keystroke
1082	R	R
1083	S	S
1084	T	T
1085	U	U
1086	V	V
1087	W	W
1088	X	X
1089	Y	Y
1090	Z	Z
1091	%K	[
1092	%L	\
1093	%M	]
1094	%N	^
1095	%O	_
1096	%W	`
1097	+A	a
1098	+B	b
1099	+C	c
1100	+D	d
1101	+E	e
1102	+F	f
1103	+G	g
1104	+H	h
1105	+I	i
1106	+J	j
1107	+K	k
1108	+L	l
1109	+M	m
1110	+N	n
1111	+O	o



**Table 34. ASCII Value - Code 39 Encode - Keystroke (Continued)**

ASCII Value	Full ASCII Code 39 Encode Character	Keystroke
1112	+P	p
1113	+Q	q
1114	+R	r
1115	+S	s
1116	+T	t
1117	+U	u
1118	+V	v
1119	+W	w
1120	+X	x
1121	+Y	y
1122	+Z	z
1123	%P	{
1124	%Q	
1125	%R	}
1126	%S	~
The keystroke in bold is sent only if the "Function Key Mapping" is enabled. Otherwise, the unbolded keystroke is sent.		

**Table 35. ALT Key Standard Defaults**

ALT Keys	Keystroke
2064	ALT 2
2065	ALT A
2066	ALT B
2067	ALT C
2068	ALT D
2069	ALT E
2070	ALT F
2071	ALT G
2072	ALT H
2073	ALT I

**Table 35. ALT Key Standard Defaults (Continued)**

ALT Keys	Keystroke
2074	ALT J
2075	ALT K
2076	ALT L
2077	ALT M
2078	ALT N
2079	ALT O
2080	ALT P
2081	ALT Q
2082	ALT R
2083	ALT S
2084	ALT T
2085	ALT U
2086	ALT V
2087	ALT W
2088	ALT X
2089	ALT Y
2090	ALT Z

**Table 36. Miscellaneous Key Standard Defaults**

Misc. Key	Keystroke
3001	PA 1
3002	PA 2
3003	CMD 1
3004	CMD 2
3005	CMD 3
3006	CMD 4
3007	CMD 5
3008	CMD 6
3009	CMD 7

**Table 36. Miscellaneous Key Standard Defaults (Continued)**

Misc. Key	Keystroke
3010	CMD 8
3011	CMD 9
3012	CMD 10
3013	CMD 11
3014	CMD 12
3015	CMD 13
3016	CMD 14

**Table 37. GUI Shift Keys**

GUI Shift Keys	
The Apple™ iMac keyboard has an apple key on either side of the space bar. Windows-based systems have a GUI key to the left of the left ALT key, and to the right of the right ALT key.	
Other Value	Keystroke
3048	GUI 0
3049	GUI 1
3050	GUI 2
3051	GUI 3
3052	GUI 4
3053	GUI 5
3054	GUI 6
3055	GUI 7
3056	GUI 8
3057	GUI 9
3065	GUI A
3066	GUI B
3067	GUI C
3068	GUI D
3069	GUI E
3070	GUI F
3071	GUI G
3072	GUI H

**Table 37. GUI Shift Keys (Continued)**

GUI Shift Keys	
The Apple™ iMac keyboard has an apple key on either side of the space bar. Windows-based systems have a GUI key to the left of the left ALT key, and to the right of the right ALT key.	
Other Value	Keystroke
3073	GUI I
3074	GUI J
3075	GUI K
3076	GUI L
3077	GUI M
3078	GUI N
3079	GUI O
3080	GUI P
3081	GUI Q
3082	GUI R
3083	GUI S
3084	GUI T
3085	GUI U
3086	GUI V
3087	GUI W
3088	GUI X
3089	GUI Y
3090	GUI Z

**Table 38. PF Key Standard Default Table**

PF Keys	Keystroke
4001	PF 1
4002	PF 2
4003	PF 3
4004	PF 4
4005	PF 5
4006	PF 6
4007	PF 7

**Table 38. PF Key Standard Default Table (Continued)**

PF Keys	Keystroke
4008	PF 8
4009	PF 9
4010	PF 10
4011	PF 11
4012	PF 12
4013	PF 13
4014	PF 14
4015	PF 15
4016	PF 16

**Table 39. F key Standard Default Table**

F Keys	Keystroke
5001	F 1
5002	F 2
5003	F 3
5004	F 4
5005	F 5
5006	F 6
5007	F 7
5008	F 8
5009	F 9
5010	F 10
5011	F 11
5012	F 12
5013	F 13
5014	F 14
5015	F 15
5016	F 16
5017	F 17
5018	F 18

**Table 39. F key Standard Default Table (Continued)**

F Keys	Keystroke
5019	F 19
5020	F 20
5021	F 21
5022	F 22
5023	F 23
5024	F 24

**Table 40. Numeric Key Standard Default Table**

Numeric Keypad	Keystroke
6042	*
6043	+
6044	Undefined
6045	-
6046	.
6047	/
6048	0
6049	1
6050	2
6051	3
6052	4
6053	5
6054	6
6055	7
6056	8
6057	9
6058	Enter
6059	Num Lock

---

**Table 41. Extended Keypad Standard Default Table**

Extended Keypad	Keystroke
7001	Break
7002	Delete
7003	Pg Up
7004	End
7005	Pg Dn
7006	Pause
7007	Scroll Lock
7008	Backspace
7009	Tab
7010	Print Screen
7011	Insert
7012	Home
7013	Enter
7014	Escape
7015	Up Arrow
7016	Dn Arrow
7017	Left Arrow
7018	Right Arrow

---

# NOTES



# Appendix G

## RS-232 Host Commands

---

The RS-232 interface will accept commands from a POS host. The available commands are:

- Disable Scanner
- Enable Scanner
- Reset Scanner
- Beep Good Read Tone
- Force Good Read Beep

**Disable Scanner Command (ASCII 'D')** — places the scanner in an operational mode in which the scanner does not accept barcode data input from the scan optics. The Laser is disabled while the scanner is disabled. Once the command is accepted and implemented by the scanner, the green indicator LED flashes to indicate the disabled status. This state is cleared if:

- 1) an Enable Command is sent
- 2) a Reset Command is sent
- 3) power is cycled to the scanner.

**Enable Scanner Command (ASCII 'E')** — places the scanner in a normal operational mode in which the scanner will accept barcode label data input from the scan optics.

**Reset Scanner Command (ASCII 'R')** — performs a scanner reset operation. Any barcode data the scanner may be holding in buffers is discarded.

**Good Read Beep Command (ASCII 'B')** — causes the scanner to sound one Good Read Beep tone if scanner and Good Decode Beep are both enabled.

**Force Beep Command (Hex '01')** — forces the scanner's beeper to sound one Good Read Beep tone regardless of, and overriding, any other current scanner setting.

---

# NOTES

# Index

## A

### ADF

- invalid rule 15
- transmit error 10, 15

### advanced data formatting 10, 15

### ASCII values

- keyboard wedge 64
- RS-232 49
- USB 84

## B

### bar code defaults

- keyboard wedge 56
- RS-232 33
- sybologies 96
- USB 76

### bar codes

- cancel 166
- keyboard wedge
  - alternate numeric keypad emulation 61
  - caps lock on 61
  - caps lock override 62
  - country keyboard types (country codes) 58
  - host types 57
  - ignore unknown characters 59
  - intra-keystroke delay 60
  - keystroke delay 60
- numeric bar codes 166
- RS-232
  - baud rate 37
  - beep on 46
  - check receive errors 40
  - data bits 39
  - hardware handshaking 41
  - host serial response time-out 45
  - host types 36
  - ignore unknown characters 48
  - intercharacter delay 47

### Nixdorf Beep/LED options 48

- RTS line state 46
- stop bit select 39

### RS-232 parameters

- parity 38

### sybologies

- bi-directional redundancy 145
- bookland EAN, enable/disable 101
- Chinese 2 of 5, enable/disable 132
- codabar CLSI editing 135
- codabar lengths 133, 134
- codabar NOTIS editing 136
- codabar, enable/disable 133
- code 11 check digit verification 125
- code 11 lengths 123
- code 11, transmit check digits 126
- code 128, enable/disable 111
- code 39
  - transmit buffer 119
- code 39 buffering 118
- code 39 check digit verification 116
- code 39 full ASCII conversion 117
- code 39 lengths 114
- code 39 transmit check digit 116
- code 39, enable/disable 112
- code 93 lengths 121
- code 93, enable/disable 120
- convert UPC-E to UPC-A 109
- convert UPC-E1 to UPC-A 109
- discrete 2 of 5 lengths 131
- discrete 2 of 5, enable/disable 130
- EAN-13/EAN-8, enable/disable 101
- EAN-8/JAN-8 extend 110
- I 2 of 5 check digit verification 129

---

- I 2 of 5 convert to EAN-13 130
- I 2 of 5 lengths 127
- I 2 of 5 transmit check digit 129
- I 2 of 5, enable/disable 126
- intercharacter gap 146
- ISBT 128, enable/disable 112
- MSI check digit algorithm 139
- MSI check digits 138
- MSI lengths 137, 138
- MSI transmit check digits 139
- MSI, enable/disable 136
- redundancy levels 142
- RSS, convert to UPC/EAN 141
- RSS, enable/disable 140
- security levels 144
  - bi-directional redundancy 145
- supplementals 102
- trioptic code 39, enable/disable 113
- UCC coupon extended code 110
- UCC/EAN-128, enable/disable 111
- UPC/EAN/JAN supplemental redundancy 104
- UPC-A preamble 106
- UPC-A transmit check digit 104
- UPC-A/UPC-E, enable/disable 99
- UPC-E preamble 107
- UPC-E transmit check digit 105
- UPC-E1 preamble 108
- UPC-E1 transmit check digit 105
- UPC-E1, enable/disable 100

**USB**

- caps lock override 80
- country keyboard types 78
- device type 77
- keystroke delay 80
- unknown characters 81

bar codes RS-232

- software handshaking 43

## C

- character set 49, 64, 84
- Chinese 2 of 5 bar codes 132
- codabar bar codes 133
- code 11 bar codes 122

- code 128 bar codes 111
- code 39 bar codes 112
- code 93 bar codes 120
- code identifiers
  - AIM code IDs 157

## D

- DataBar, convert to UPC/EAN 141
- DataBar, enable/disable 140
- default parameters
  - keyboard wedge 56
  - RS-232 33
  - symbolologies 96
  - USB 76
- Depth of Field Chart 14
- discrete 2 of 5 bar codes 130
- DTF bar codes 130

## E

- error indications
  - ack/nak 43
  - ADF 10, 15
  - enq 43
  - format 10, 16
  - input 10, 15
  - RS-232 10, 15
  - RS-232 transmission 41
  - symbolologies 95
  - transmission 10, 11, 15, 45
  - unknown characters 48, 59, 81
  - xon/xoff 43

## F

- Field, Depth of 14

## G

- Getting Started 1, 5, 9, 15, 19, 55

## H

- Host Commands 179
- host types

---

keyboard wedge 57  
RS-232 36  
USB 77

## I

intercharacter gap 146  
interleaved 2 of 5 bar codes 126

## K

keyboard wedge connection 55  
keyboard wedge defaults 56  
keyboard wedge parameters 57

## M

MSI bar codes 136

## N

NW - 7 133

## P

parameter defaults  
    keyboard wedge 56  
    RS-232 33  
    sybologies 96  
    USB 76  
parameters  
    keyboard wedge 57  
    RS-232 33  
    sybologies 96  
    USB 77  
Product Specifications 147

## R

RS-232 connection 32  
RS-232 defaults 33  
RS-232 parameters 33  
RSS bar codes  
    reduced space symbology 140

## S

sample bar codes  
    code 128 161  
    code 39 162  
    interleaved 2 of 5 162  
    UPC/EAN 161  
scanning  
    errors 59, 81  
    sybologies sequence example 95  
security level bar codes  
    bi-directional redundancy 145  
security levels 142, 144  
Serial Output 150  
setup  
    connecting a USB interface 75  
    connecting an RS-232 interface 32  
    connecting keyboard wedge inter-  
        face 55  
Standard 149  
Standard Cable Pinouts 149  
sybologies defaults 96

## U

UPC/EAN bar codes 99  
USB connection 75  
USB defaults 76  
USB parameters 77

---

# NOTES





[www.datalogic.com](http://www.datalogic.com)

© 2007-2014 Datalogic ADC, Inc. • All rights reserved. •  
Datalogic and the Datalogic logo are registered trademarks of  
Datalogic S.p.A. in many countries, including the U.S.A. and the E.U.

**Datalogic ADC, Inc.**

959 Terry Street | Eugene | OR 97402 | USA  
Telephone: (1) 541-683-5700 | Fax: (1) 541-345-7140

